

Product Specifications

Customer	
Model Name	NTWP238-2 V502E
Model Number	NTWP238<u>XX2XX</u>-GI<u>XX8XX</u>-<u>XXXX</u>-502E

* X = A~Z, 0~9 (Depends on Options.)



Records of Revision			
Vision	Modifying	Old Description	New Description
v2209.1	Preliminary Specification		
v2209.2	Add Stylus Pen Option		
v2209.3	New trademark released		

Nextech WP Series 23.8" All-in-one Industrial Touch PC

NTWP238-2 V502E

Features

- ★ 23.8" Industrial Grade Panel, 16:9/1920x1080 (FHD) Resolution
- ★ AHVA Wide Viewing Angle Technology (178°/178°)
- ★ Intel® Quad-Core N3350/N4200 CPU
- ★ DDR3 8G DRAM
- ★ Narrow Bezel, True Flat Projected Capacitive Touch Screen
- ★ 7H Hardness Tempered Cover Glass
- ★ 10 points Multi-touch, Supports NEXTECH Dedicated Stylus
- ★ Metal Cabinet with Diverse Combine Options
- ★ Made in Taiwan, 3 Years Warranty
- ★ Optional High Brightness 1500nits, for Outdoor Environment
- ★ Optional AG Coating/Antibacterial/Privacy Filter Surface Treatment



PSE



BSMI



RoHS



CE



ISO9001



FCC



Desktop Stand



Wall Mounting



Open-frame Brackets



Panel Mount

System Specifications

CPU	Intel® Celeron/Pentium Processor
Memory	DDR3 SO-DIMM 8G
Storage	SATAx1, M.2 M-key (SATA 6Gb/s) x1, Full-size Mini PCIe Slot x1
GPU	Intel® HD Graphics 500
Sound Chip	Realtek® Audio CODEC
Network	Intel® i211AT Gbe LAN Chips x2

Display Specifications

Screen Diagonal	23.8 inch	Display Mode	VA Mode, Normally Black
Display Area	527.04x296.46 mm	Backlight Unit	LED (white LED)
Resolution	1920x1080 (FHD)	Viewing Angle (L/R, U/D)	178°/178° (CR=10)
Contrast Ratio	3000:1	Response Time	16 msec.
Display Ratio	16:9	Backlight Lifetime	>30,000 Hours
Support Colors	16.7M Colors	Operating Temp.	0~50°C
Pixel Pitch	274.5x274.5 um	Storage Temp.	-20~60°C

Display Options

Brightness			
	Brightness	Environment	Model Name
Standard	400nits	General	NTWP238NX2XX-GIXX8XX-XXXX-502E
Option 1	1000nits	Outdoor Environment	NTWP238AX2XX-GIXX8XX-XXFX-502E
Option 2	1500nits	Sunlight Readable	NTWP238FX2XX-GIXX8XX-XXFX-502E

Touch Options

Projected Capacitive			
Model Name	NTWP238 <u>P</u> 2XX-G <u>I</u> X <u>X</u> 8XX- <u>X</u> XXX-502E		
Touch Technology	Projected Capacitive	Thickness of Cover Lens	2.9±0.2mm
Allowed Touch Points	10 points	Hardness of Cover Lens	7H
Transparency	≥87%	IK Ratings	IK07
Accuracy	99.00%		

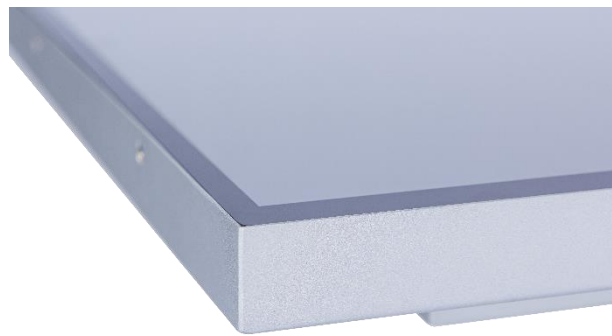

* True Flat, 1mm Bezel

Non-Touch	
Model Name	NTWP238 <u>0</u> 2XX-G <u>I</u> X <u>X</u> 8XX- <u>X</u> XXX-502E

Surface Treatment		
	Description	Model Name
Standard	(none)	NTWP238XX2<u>00</u>-G<u>I</u>X<u>X</u>8XX-<u>X</u>XXX-502E
Option 1	Anti-Glare Coating	NTWP238XX2 <u>GG</u> -G <u>I</u> X <u>X</u> 8XX- <u>X</u> XXX-502E
Option 2	Antibacterial (AB Film)	NTWP238XX2 <u>AB</u> -G <u>I</u> X <u>X</u> 8XX- <u>X</u> XXX-502E
Option 3	Anti-Spy (AS Film)	NTWP238XX2 <u>SF</u> -G <u>I</u> X <u>X</u> 8XX- <u>X</u> XXX-502E

System Options

CPU		
	Item	Model Name
Standard	N3350	NTWP238XX2XX-GIC18XX-XXXX-502E
Option	N4200	NTWP238XX2XX-GIC28XX-XXXX-502E

Storage		
	Item	Model Name
Standard	SSD 128G	NTWP238XX2XX-GIXX8S1-XXXX-502E
Option 1	SSD 256G	NTWP238XX2XX-GIXX8S2-XXXX-502E
Option 2	SSD 512G	NTWP238XX2XX-GIXX8S3-XXXX-502E
Option 3	SATA HDD 1T	NTWP238XX2XX-GIXX8H1-XXXX-502E
Option 4	SSD 128G + SATA HDD 1T	NTWP238XX2XX-GIXX8SH-XXXX-502E

Material of Cabinet		
	Description	Model Name
Standard	SECC	NTWP238XX2XX-GIXX8XX-SXXX-502E
Option 1	Stainless Steel	NTWP238XX2XX-GIXX8XX-LXXX-502E
Option 2	Aluminum	NTWP238XX2XX-GIXX8XX-AXXX-502E

Color of Cabinet		
	Description	Model Name
Standard	Silver	NTWP238XX2XX-GIXX8XX-XSXX-502E
Option 1	White	NTWP238XX2XX-GIXX8XX-XWXX-502E
Option 2	Black	NTWP238XX2XX-GIXX8XX-XBXX-502E
Options	Other Colors	NTWP238XX2XX-GIXX8XX-XXXX-502E

* X = A~Z, 0~9 (Depends on Color)

System Options (Continued)

Cooling Fan		
	Description	Model Name
Standard	Fanless	NTWP238XX2XX-GIXX8XX-XX0X-502E
Option	7 Blades/4000r.p.m/28.3dB	NTWP238XX2XX-GIXX8XX-XXFX-502E

Power Input		
	Description	Model Name
Standard	9~36VDC-in, with AC/DC Adapter	NTWP238XX2XX-GIXX8XX-XXX4-502E
Option	100~240V AC, C14 AC Power Socket	NTWP238XX2XX-GIXX8XX-XXXA-502E



DC-in



AC-in

Passive Stylus Pen (Option)	
Technology	Passive High Sensitive Knitted Wire Mesh Fiber Tip
Size of tip	6mm
Magnetic Attachment	Yes

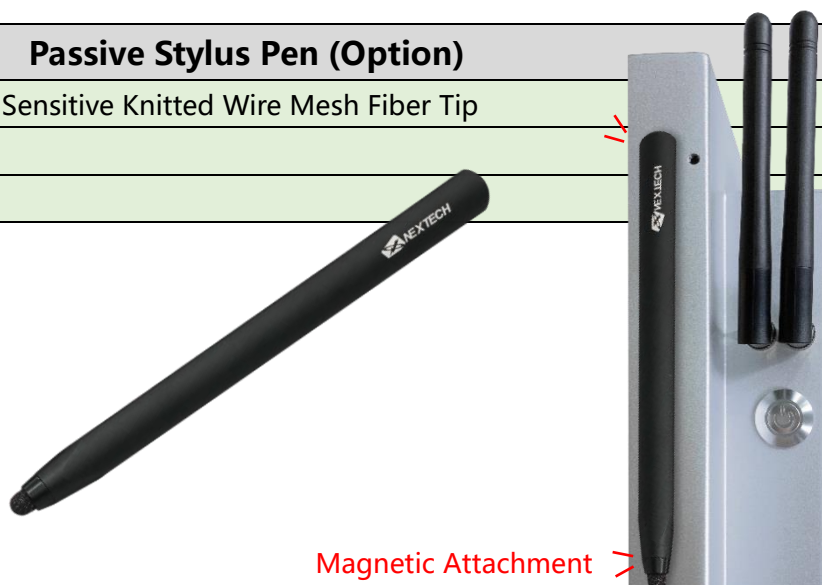

Magnetic Attachment

Input /Output System

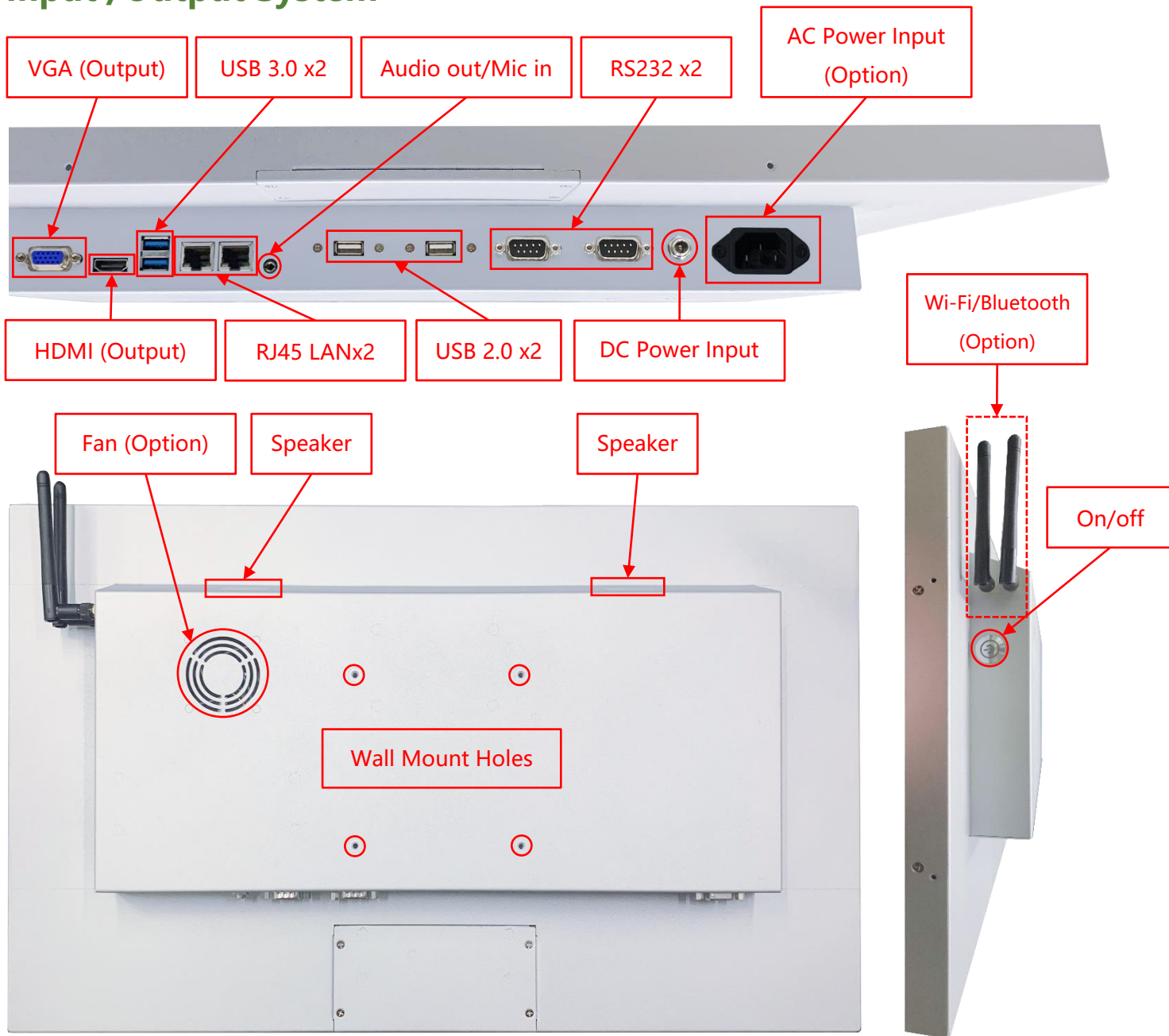

Input / Output	Connectors	Input / Output	Connectors
HDMI (Output)	1	USB 3.0	2
VGA (Output)	1	USB 2.0	2
Audio Output /Mic Input (3.5mm)	1	RS232	2
DC Power Input	1	LAN (RJ45)	2
AC Power Input	Option	Wi-Fi/Bluetooth & Antenna	Option
Speakers	2W x2		

Front Cover (Option)

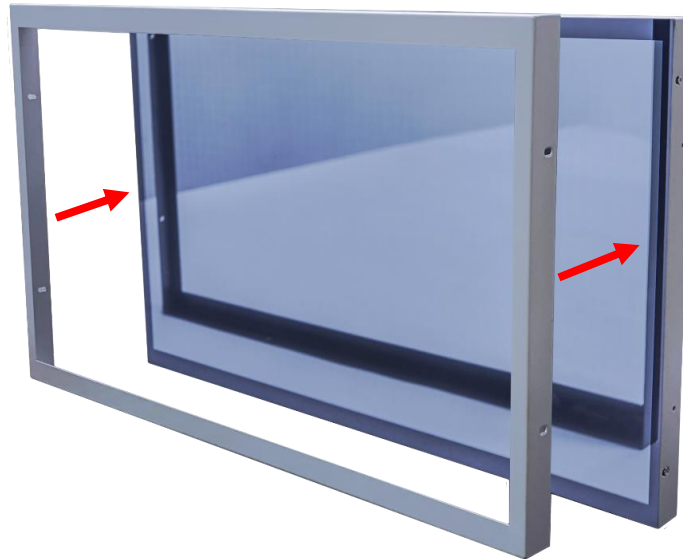

The standard **NTWP238** is true flat surface, with only 1mm metal bezel.
To protect the corners of the touch screen, the **Front Cover** can be added.

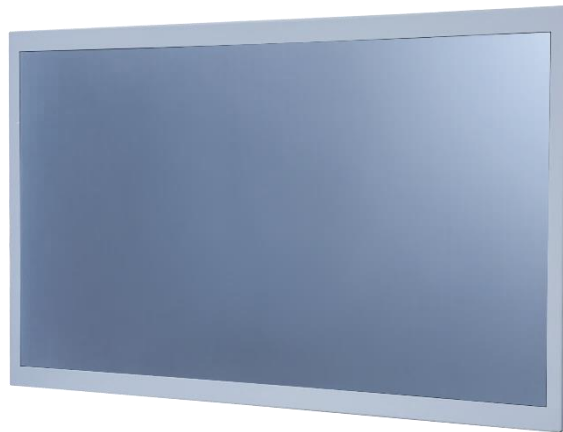

The watertight gasket can be added between the **Front Cover** and **NTWP238**.
It complies **IP65** on front.

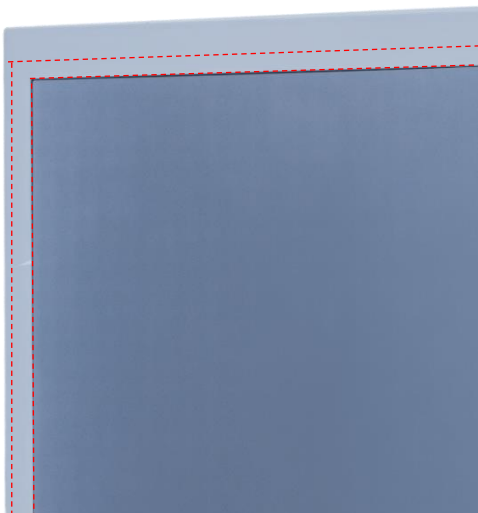

Open-frame Brackets (Option)

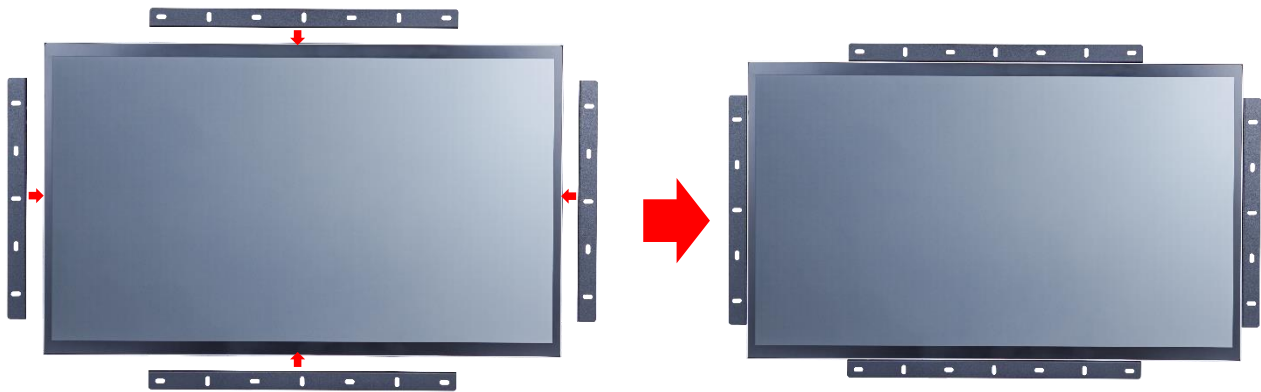

Dimension for Installing with Open-frame Brackets

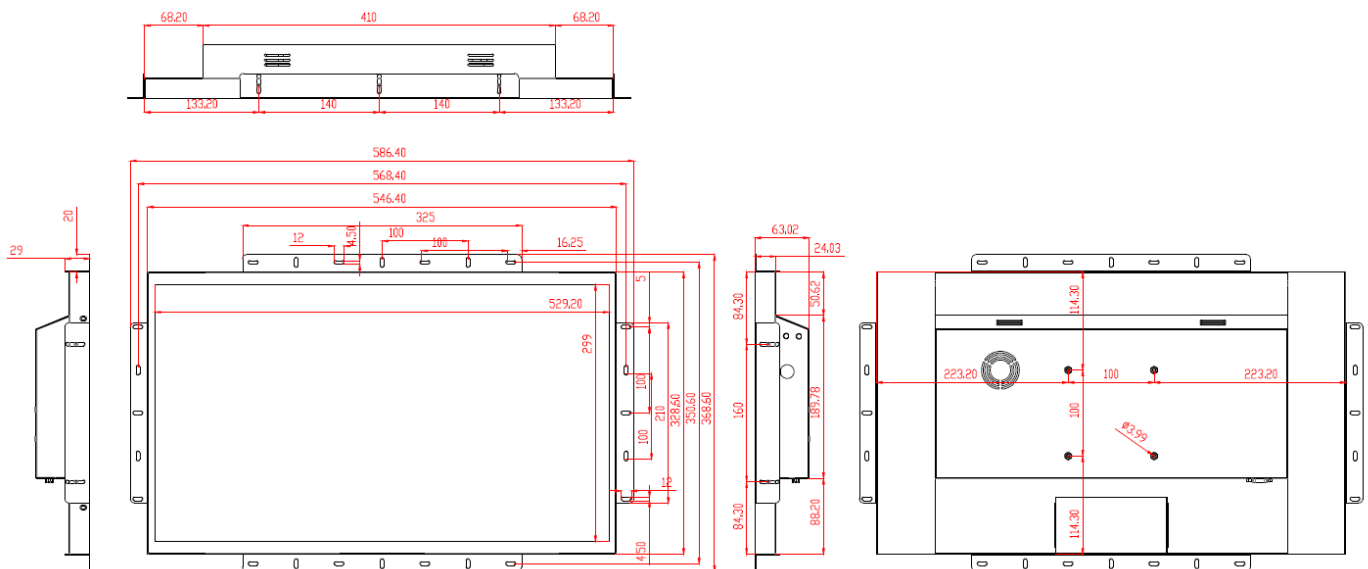

Panel Mount Kits (Option)

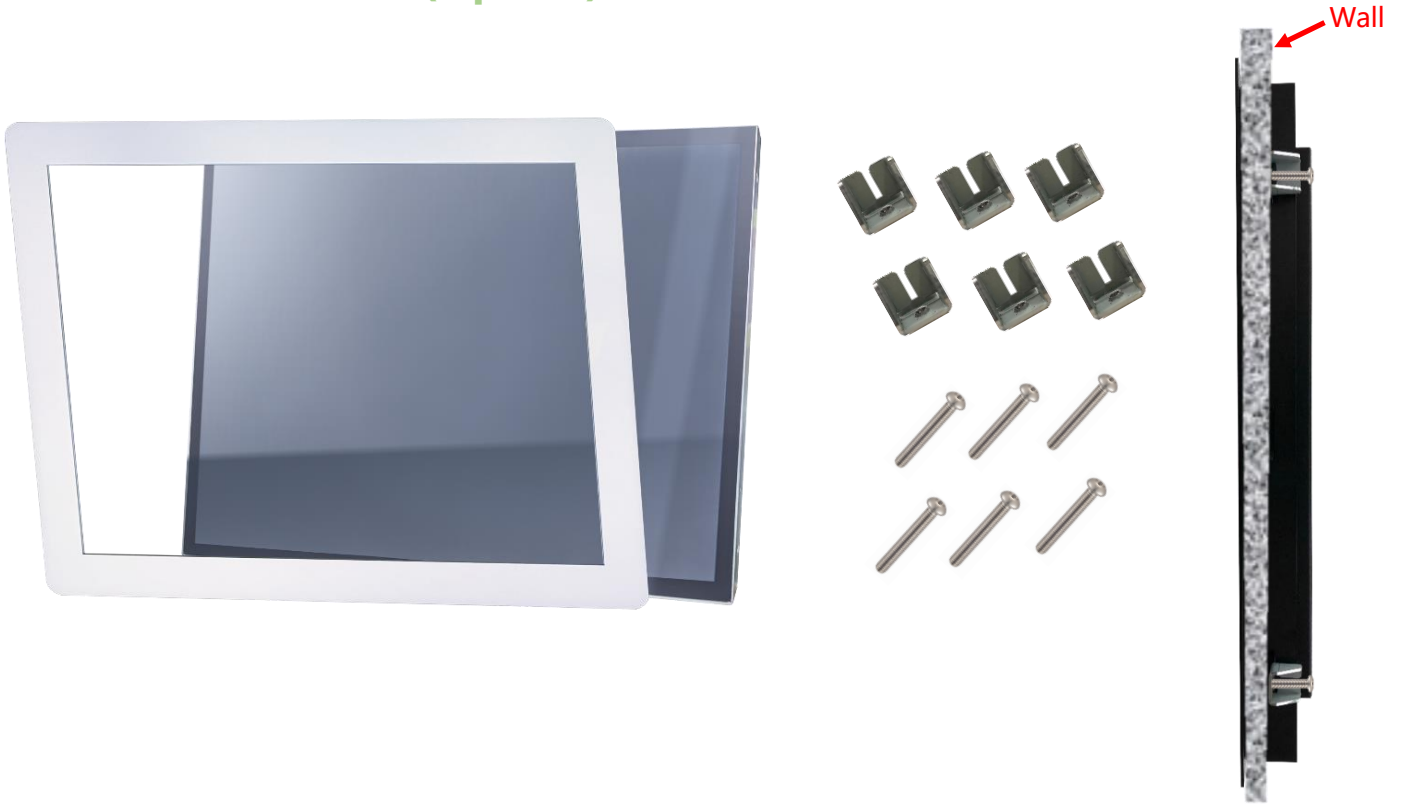

Dimension for Installing with Panel Mount Kits

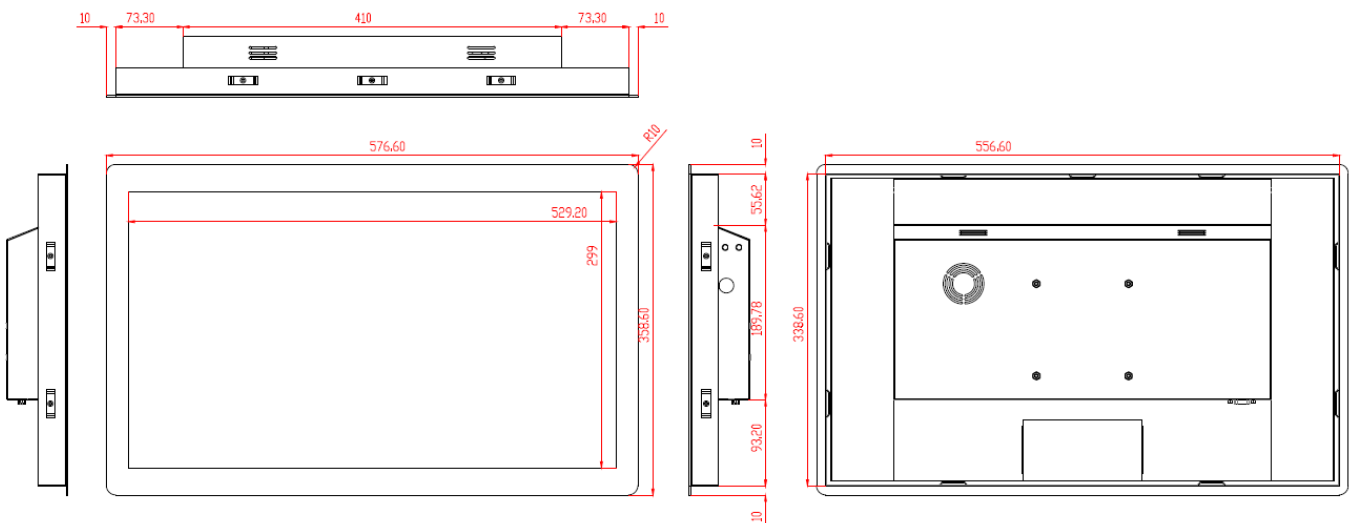

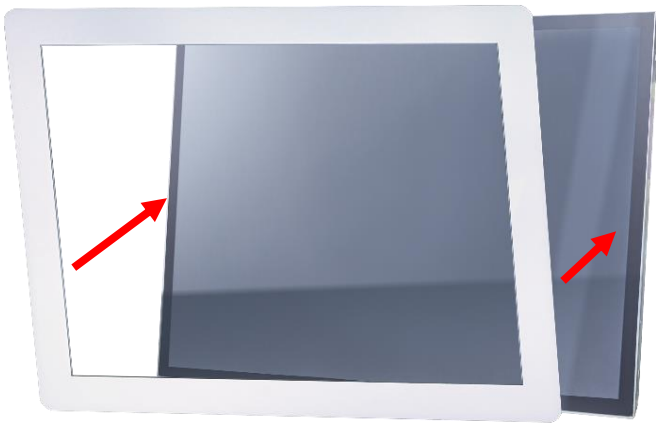

Step 1: Assemble the front module with the screen body. (This step is pre-assembled at the factory.)

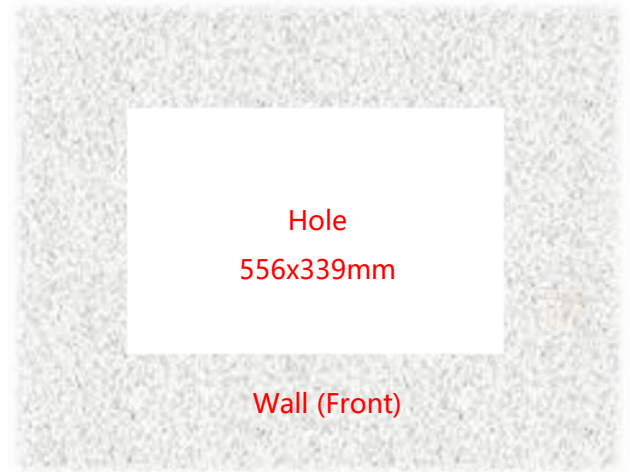

Step 2: Insert the screen from the front into the pre-cut opening.

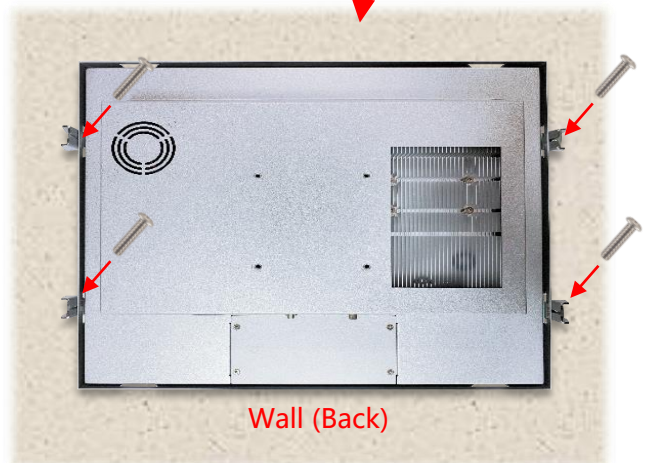

Step 3: Attach the clips from the back and secure with screws. (Up to 9 clips can be installed as needed or per positional limitations.)

Nextech WP Series 23.8" All-in-one Industrial Touch PC

NTWP238-2 V502E

Desktop Stand (Option)

Item	B Stand	Part No.	DST-0B002/DST-1B002
Mounting Pattern	100x100 / 75x75 mm	Dimension (WxHxD)	203x275x227 mm
Material	Steel/Plastic/Aluminum	Net Weight	1.8 KG
Tilt (Hinge)	-2° ~ +180°	Support Max. Weight	15 KG



Item	Z Stand	Part No.	DST-0BZ01/DST-1BZ01
Mounting Pattern	100x100 / 75x75 mm	Dimension (WxHxD)	190x240x41.6
Material	SECC	Net Weight	2.6 KG
Tilt (Hinge)	±360°	Support Max. Weight	15 KG

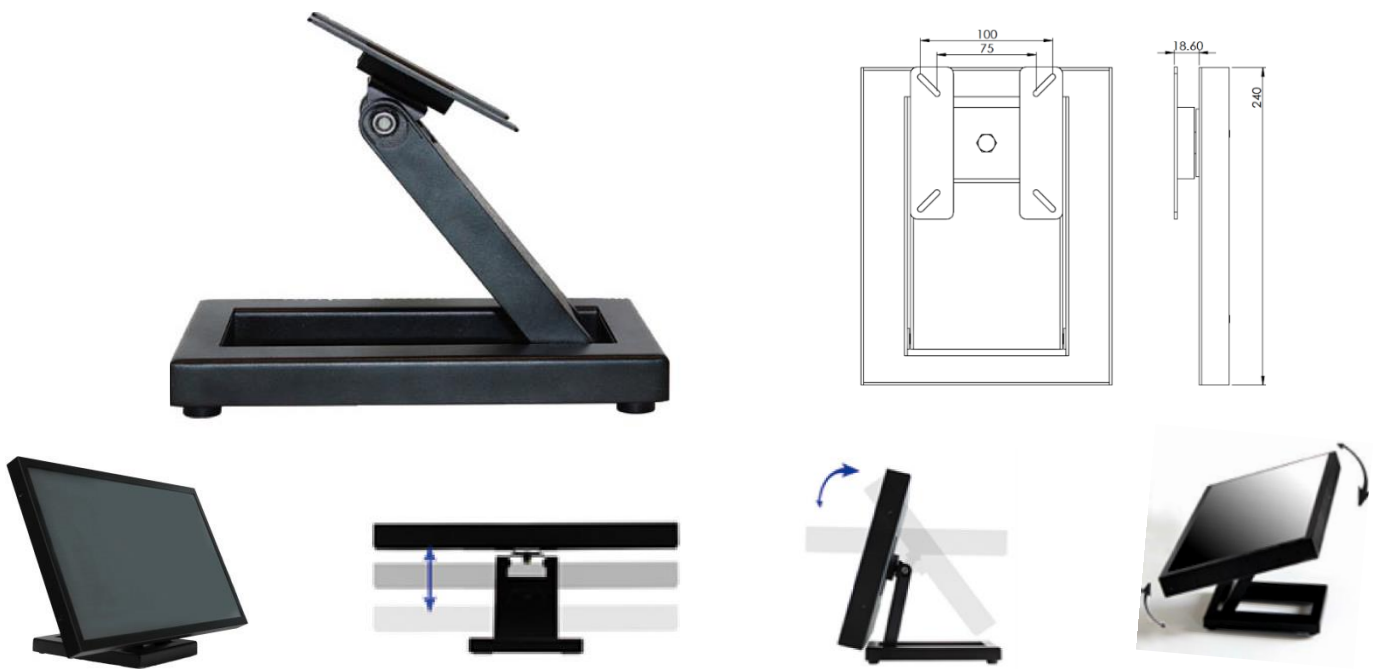

Wall Mount Bracket (Option)

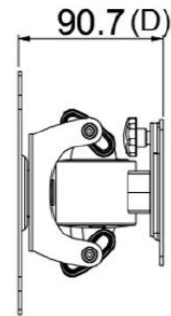
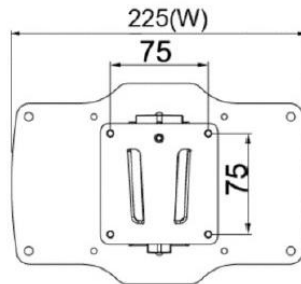
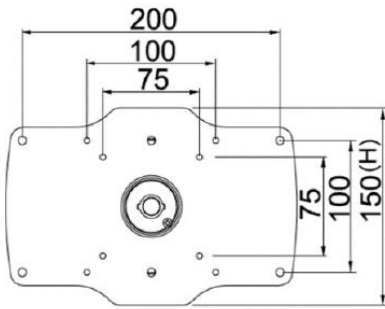
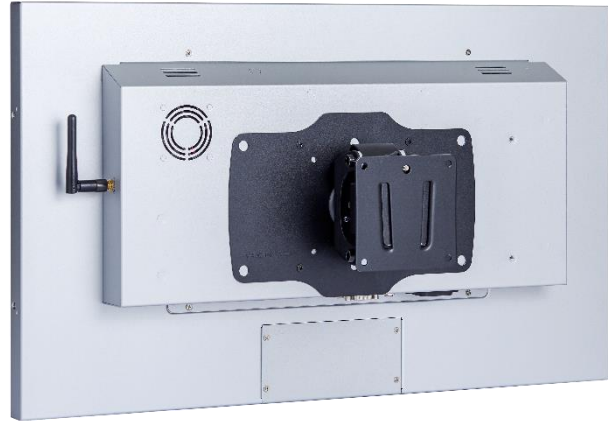

Packing Information



Unit Carton Size	665x160x510 mm
Unit N. Weight	≤6.1 KG
Unit G. Weight	≤8.1 KG
Units per Pallet	30 units
Pallet Size	120x100x171 CM

Physical Specifications

Dimension	546x329x63(±2)mm	Net Weight	≤6.1 KG
VESA Mounting	100x100 mm	Gross Weight	≤8.1 KG

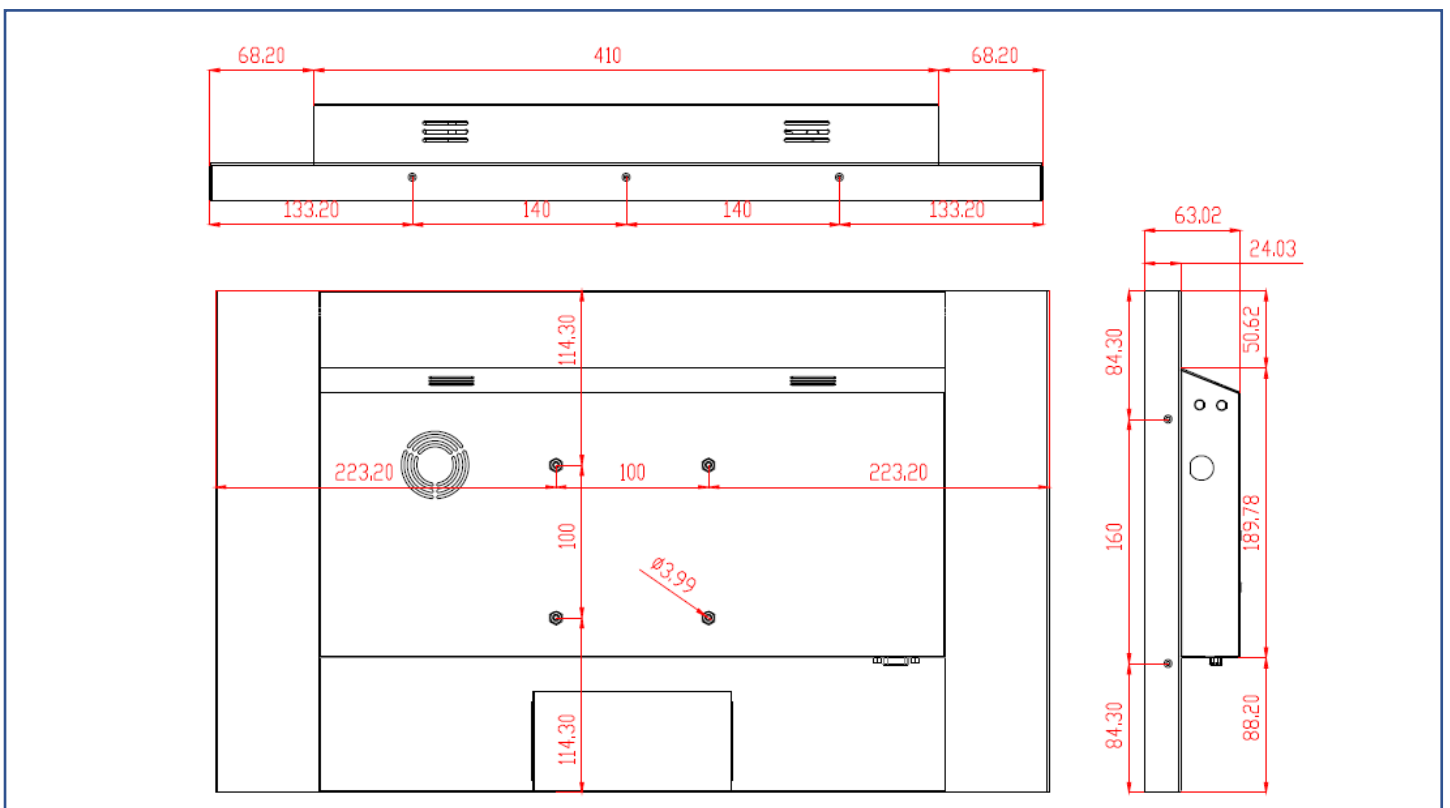
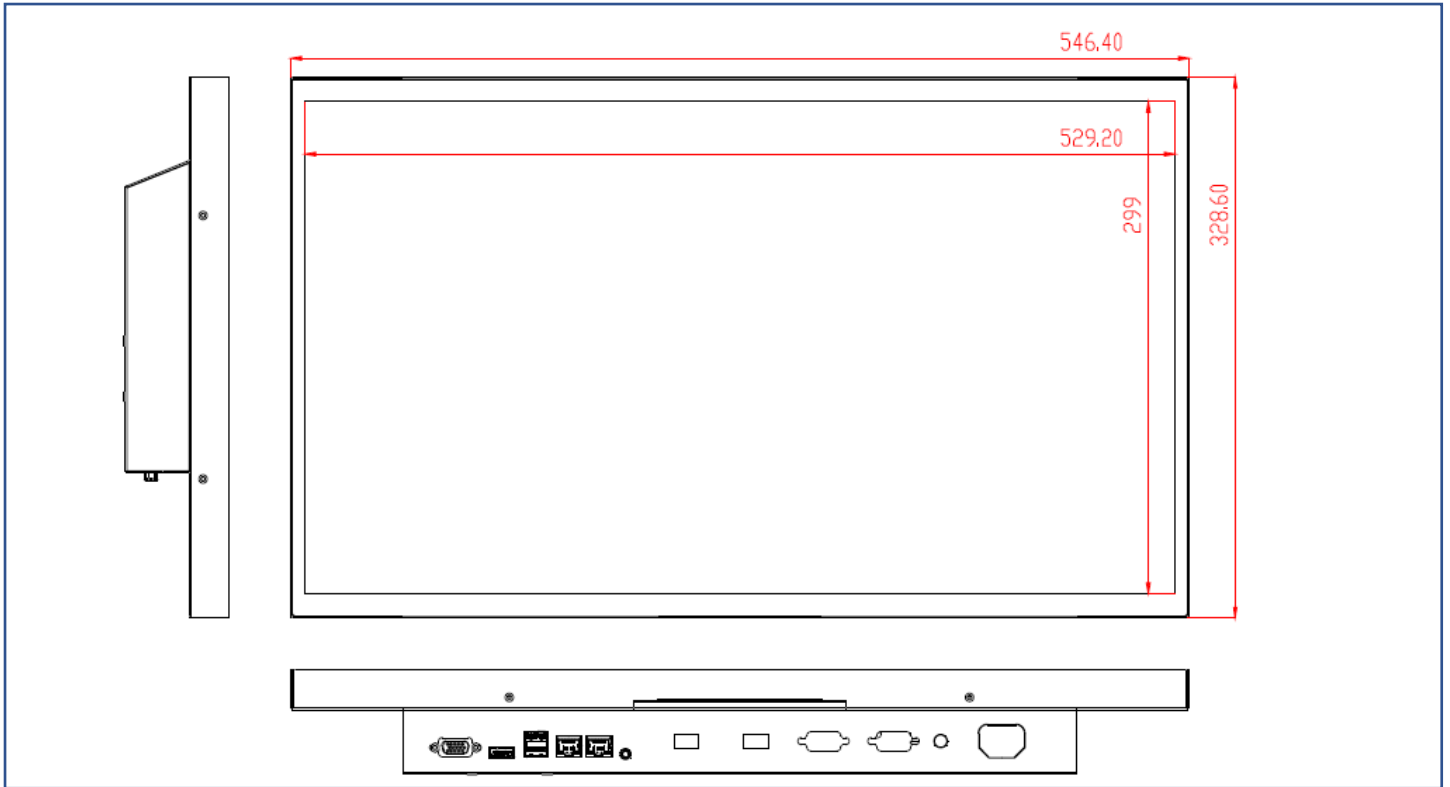

Cosmetic Inspection Standard

Display Area Allowance			
Defect description	Defective Specifications	Allowance	Remarks
Dot Defect (including dark dot, particles, bubbles, pits, dust, foreign matter)	$D \leq 0.2\text{mm}$	Ignored	D=Diameter
	$0.2 < D \leq 0.7\text{mm}$	$N \leq 5$	N=Quantity
	$0.7 < D \leq 1\text{mm}$	$N \leq 3$	
	$D > 1\text{mm}$	$N \leq 0$	
Linear Defect (including scratches, fluff, particles)	$W \leq 0.15\text{mm}$	Ignored	W=Width
	$0.15 < W \leq 0.5\text{mm}, L \leq 15\text{mm}$	$N \leq 2$	L=Length
	$W > 0.5\text{mm}$ or $L > 15\text{mm}$	NG	

* Visual inspection distance: 60cm, 90 degree (same for front/side/back)

Front Appearance Allowance (Including Coating)			
Defect description	Defective Specifications	Allowance	Remarks
Dot Defect (including particles, bubbles, pits...etc.)	$D \leq 0.7\text{mm}$	Ignored	D=Diameter
	$0.7 < D \leq 1.5\text{mm}$	$N \leq 3$	N=Quantity
	$D > 1.5\text{mm}$	$N \leq 0$	
Linear Defect (including scratches, fluff, particles)	$W \leq 0.2\text{mm}, L \leq 15\text{mm}$	Ignored	W=Width, L=Length
	$0.2 < W \leq 0.7\text{mm}, L \leq 15\text{mm}$	$N \leq 1$	
	$W > 0.7\text{mm}$ or $L > 15\text{mm}$	NG	

Side / Back Appearance Allowance (Including Coating)			
Defect description	Defective Specifications	Allowance	Remarks
Dot Defect (including particles, bubbles, pits...etc.)	$D \leq 1.5\text{mm}$	Ignored	D=Diameter
	$1.5 < D \leq 3\text{mm}$	$N \leq 8$	N=Quantity
	$D > 3\text{mm}$	$N \leq 2$	
Linear Defect (including scratches, fluff, particles)	$W \leq 0.8\text{mm}, L \leq 15\text{mm}$	Ignored	W=Width, L=Length
	$0.8 < W \leq 1.5\text{mm}, L \leq 15\text{mm}$	$N \leq 5$	
	$W > 1.5\text{mm}$ or $L > 15\text{mm}$	NG	

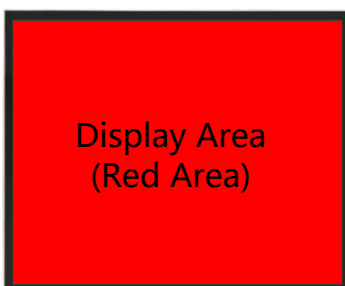

Display Area
(Red Area)



Front Appearance (Red Area)



Back Appearance