

# Product Specifications

<b>Customer</b>	
<b>Model Name</b>	<b>NTWP238-1 V502E</b>
<b>Model Number</b>	<b>NTWP238<u>XXSXX</u>-GI<u>XX8XX</u>-<u>XXXX</u>-502E</b>

\* X = A~Z, 0~9 (Depends on Options.)



Records of Revision			
Vision	Modifying	Old Description	New Description
v2209.1	Preliminary Specification		
v2209.2	Add Stylus Pen Option		
<b>v2209.3</b>	<b>New trademark released</b>		

## Features

- ★ 23.8 inch, 1920x1080 (FHD) Resolution
- ★ VA Wide Viewing Angle Technology (178°/178°)
- ★ Intel® Quad-Core N3350/N4200 CPU
- ★ DDR3 8G DRAM
- ★ Narrow Bezel, True Flat Projected Capacitive Touch Screen
- ★ 7H Hardness Tempered Cover Glass
- ★ 10 points Multi-touch, Supports NEXTECH Dedicated Stylus
- ★ Metal Cabinet with Diverse Combine Options
- ★ Made in Taiwan, 3 Years Warranty
- ★ Optional High Brightness 1500nits, for Outdoor Environment
- ★ Optional AG Coating/Antibacterial/Privacy Filter Surface Treatment



PSE



BSMI



RoHS



CE



ISO9001



FCC



Desktop Stand



Wall Mounting



Open-frame Brackets

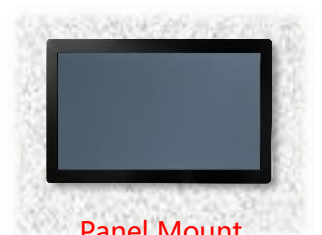

Panel Mount

## System Specifications

CPU	Intel® Celeron/Pentium Processor
Memory	DDR3 SO-DIMM 8G
Storage	SATAx1, M.2 M-key (SATA 6Gb/s) x1, Full-size Mini PCIe Slot x1
GPU	Intel® HD Graphics 500
Sound Chip	Realtek® Audio CODEC
Network	Intel® i211AT Gbe LAN Chips x2

## Display Specifications

Screen Diagonal	23.8 inch	Display Mode	VA Mode, Normally Black
Display Area	527.04x296.46 mm	Backlight Unit	LED (white LED)
Resolution	1920x1080 (FHD)	Viewing Angle (L/R, U/D)	178°/178° (CR=10)
Contrast Ratio	3000:1	Response Time	16 msec.
Display Ratio	16:9	Backlight Lifetime	>30,000 Hours
Support Colors	16.7M Colors	Operating Temp.	0~50°C
Pixel Pitch	274.5x274.5 um	Storage Temp.	-20~60°C

## Display Options

Brightness			
	Brightness	Environment	Model Name
Standard	250nits	General	NTWP238NXSXX-GIXX8XX-XXXX-502E
Option 1	1000nits	Outdoor Environment	NTWP238AXSXX-GIXX8XX-XXFX-502E
Option 2	1500nits *	Sunlight Readable	NTWP238FX2XX-GIXX8XX-XXFX-502E

\* Check the data sheets: [NTWP238-2 V502E](#)

## Touch Options

Projected Capacitive			
Model Name	NTWP238X <u>P</u> SXX-GIXX8XX-XXXX-502E		
Touch Technology	Projected Capacitive	Thickness of Cover Lens	2.9±0.2mm
Allowed Touch Points	10 points	Hardness of Cover Lens	7H
Transparency	≥87%	IK Ratings	IK07
Accuracy	99.00%		

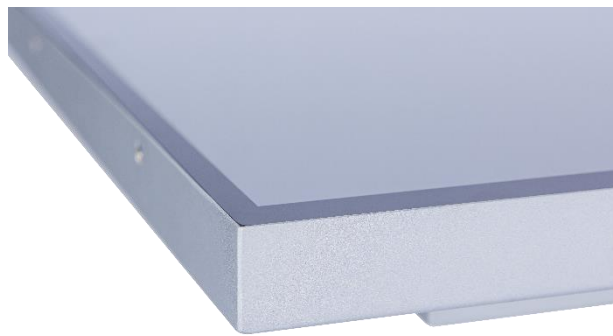

\* True Flat, 1mm Bezel

Non-Touch	
Model Name	NTWP238X <u>0</u> SXX-GIXX8XX-XXXX-502E

Surface Treatment		
	Description	Model Name
<b>Standard</b>	<b>(none)</b>	<b>NTWP238XXS<u>00</u>-GIXX8XX-XXXX-502E</b>
Option 1	Anti-Glare Coating	NTWP238XXS <u>GG</u> -GIXX8XX-XXXX-502E
Option 2	Antibacterial (AB Film)	NTWP238XXS <u>AB</u> -GIXX8XX-XXXX-502E
Option 3	Anti-Spy (AS Film)	NTWP238XXS <u>SF</u> -GIXX8XX-XXXX-502E

## System Options

CPU		
	Item	Model Name
<b>Standard</b>	<b>N3350</b>	<b>NTWP238XXSXX-GIC18XX-XXXX-502E</b>
Option	N4200	NTWP238XXSXX-GIC28XX-XXXX-502E

Storage		
	Item	Model Name
<b>Standard</b>	<b>SSD 128G</b>	<b>NTWP238XXSXX-GIXX8S1-XXXX-502E</b>
Option 1	SSD 256G	NTWP238XXSXX-GIXX8S2-XXXX-502E
Option 2	SSD 512G	NTWP238XXSXX-GIXX8S3-XXXX-502E
Option 3	SATA HDD 1T	NTWP238XXSXX-GIXX8H1-XXXX-502E
Option 4	SSD 128G + SATA HDD 1T	NTWP238XXSXX-GIXX8SH-XXXX-502E

Material of Cabinet		
	Description	Model Name
<b>Standard</b>	<b>SECC</b>	<b>NTWP238XXSXX-GIXX8XX-SXXX-502E</b>
Option 1	Stainless Steel	NTWP238XXSXX-GIXX8XX-LXXX-502E
Option 2	Aluminum	NTWP238XXSXX-GIXX8XX-AXXX-502E

Color of Cabinet		
	Description	Model Name
<b>Standard</b>	<b>Silver</b>	<b>NTWP238XXSXX-GIXX8XX-XSXX-502E</b>
Option 1	White	NTWP238XXSXX-GIXX8XX-XWXX-502E
Option 2	Black	NTWP238XXSXX-GIXX8XX-XBXX-502E
Options	Other Colors	NTWP238XXSXX-GIXX8XX-XXXX-502E

\* X = A~Z, 0~9 (Depends on Color)

## System Options (Continued)

Cooling Fan		
	Description	Model Name
<b>Standard</b>	<b>Fanless</b>	<b>NTWP238XXSXX-GIXX8XX-XX0X-502E</b>
Option	7 Blades/4000r.p.m/28.3dB	NTWP238XXSXX-GIXX8XX-XXFX-502E

Power Input		
	Description	Model Name
<b>Standard</b>	<b>9~36VDC-in, with AC/DC Adapter</b>	<b>NTWP238XXSXX-GIXX8XX-XXX4-502E</b>
Option	100~240V AC, C14 AC Power Socket	NTWP238XXSXX-GIXX8XX-XXXA-502E



DC-in



AC-in

Passive Stylus Pen (Option)	
Technology	Passive High Sensitive Knitted Wire Mesh Fiber Tip
Size of tip	6mm
Magnetic Attachment	Yes

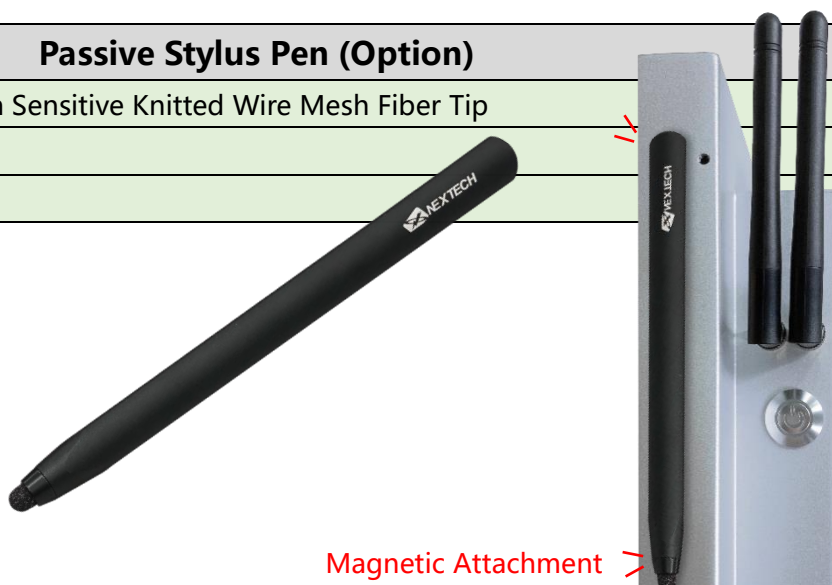

Magnetic Attachment

## Input /Output System

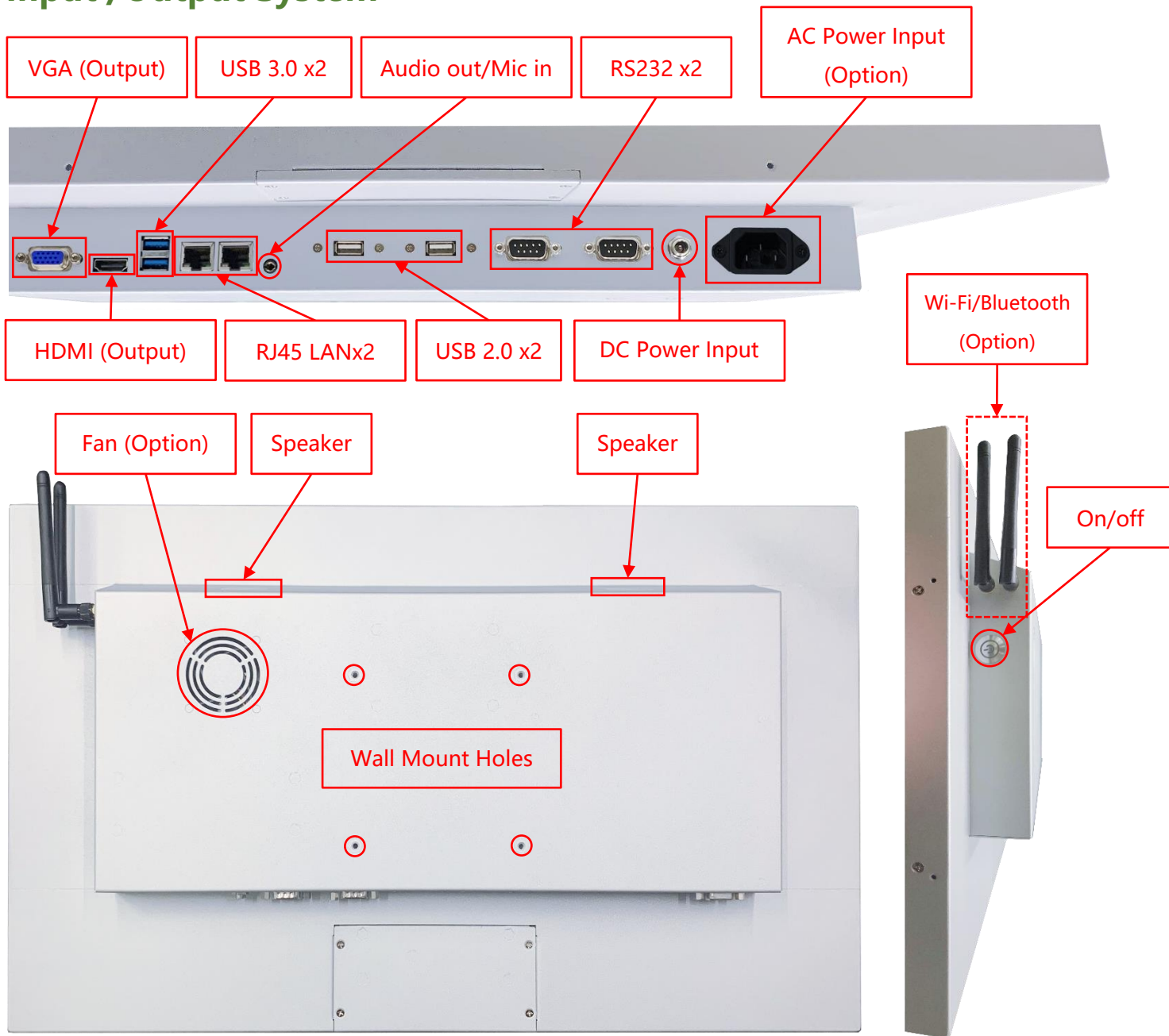

Input / Output	Connectors	Input / Output	Connectors
HDMI (Output)	1	USB 3.0	2
VGA (Output)	1	USB 2.0	2
Audio Output /Mic Input (3.5mm)	1	RS232	2
DC Power Input	1	LAN (RJ45)	2
AC Power Input	Option	Wi-Fi/Bluetooth & Antenna	Option
Speakers	2W x2		

## Front Cover (Option)

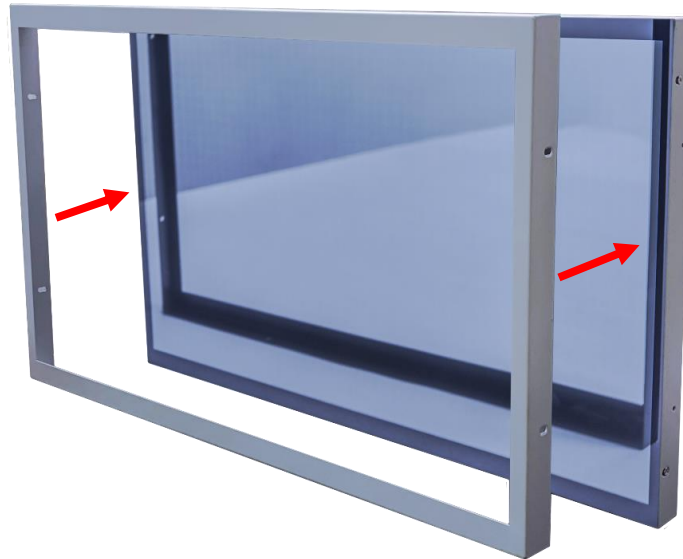

The standard **NTWP238** is true flat surface, with only 1mm metal bezel.  
To protect the corners of the touch screen, the **Front Cover** can be added.



The watertight gasket can be added between the **Front Cover** and **NTWP238**.  
It complies **IP65** on front.

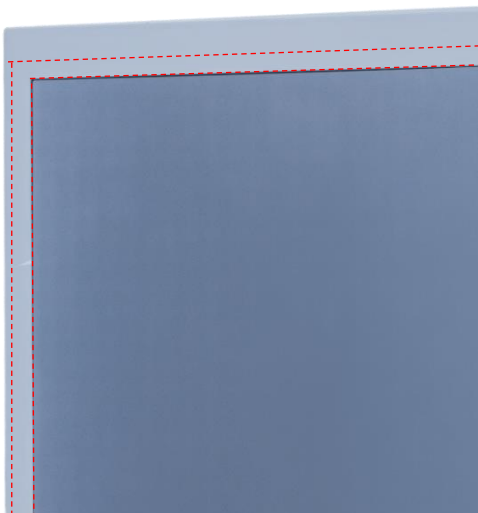



**Open-frame Brackets (Option)**

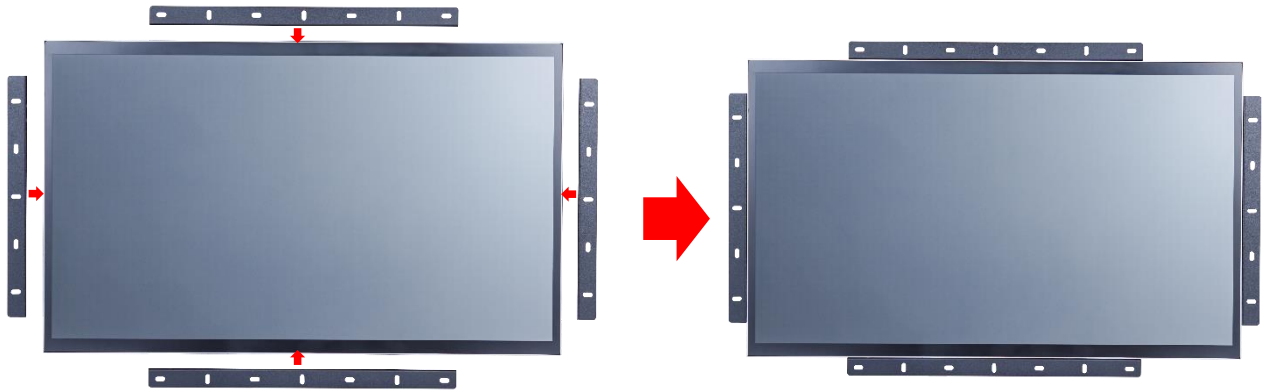

**Dimension for Installing with Open-frame Brackets**

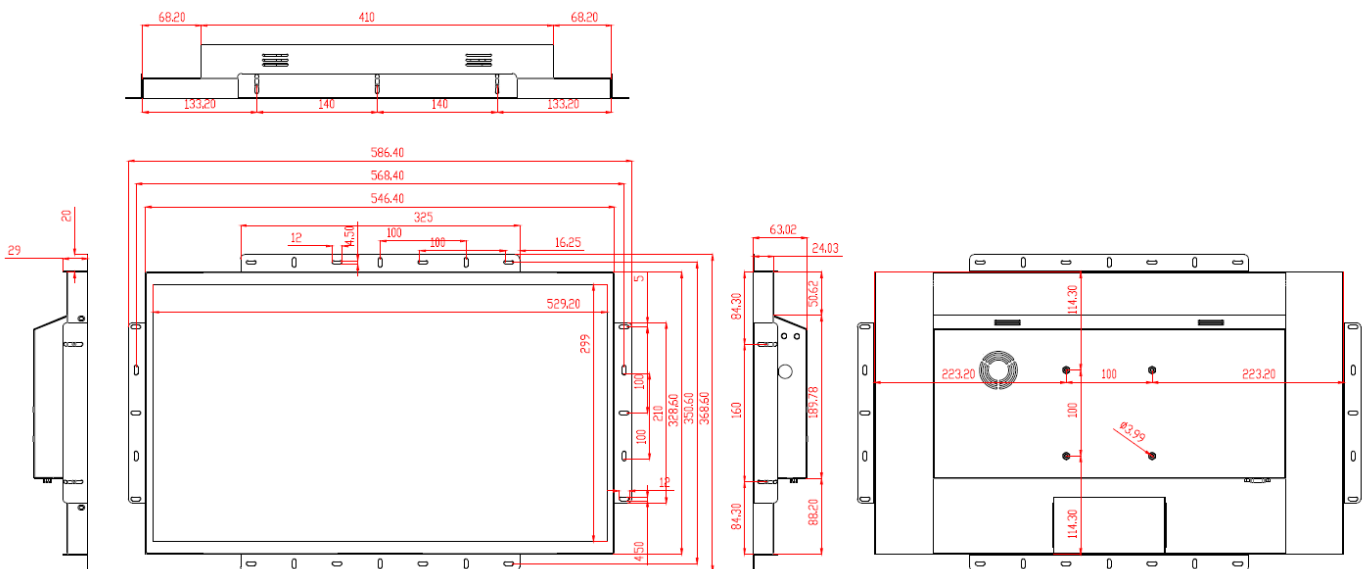

**Panel Mount Kits (Option)**

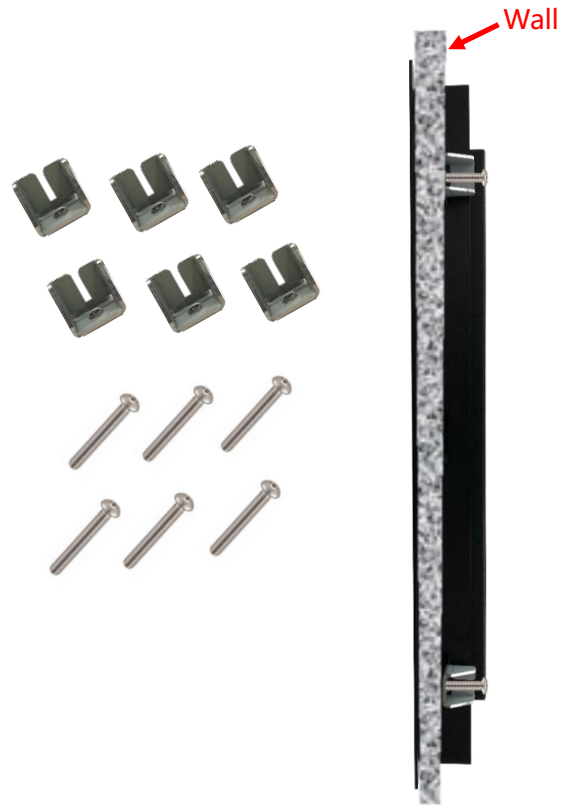
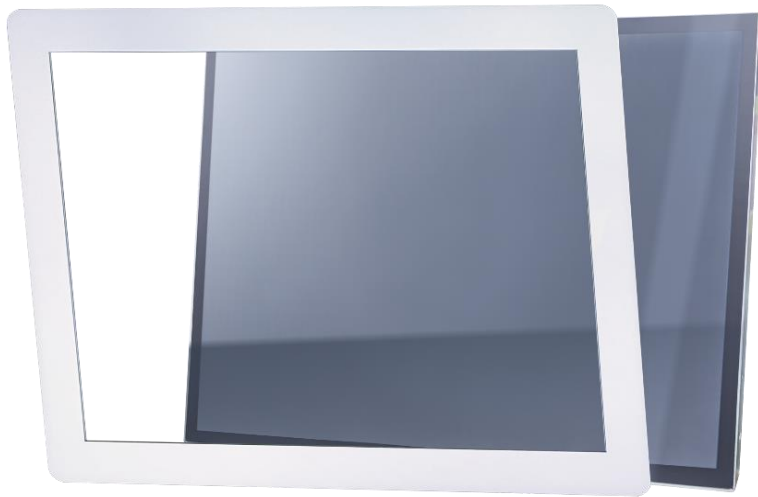

**Dimension for Installing with Panel Mount Kits**

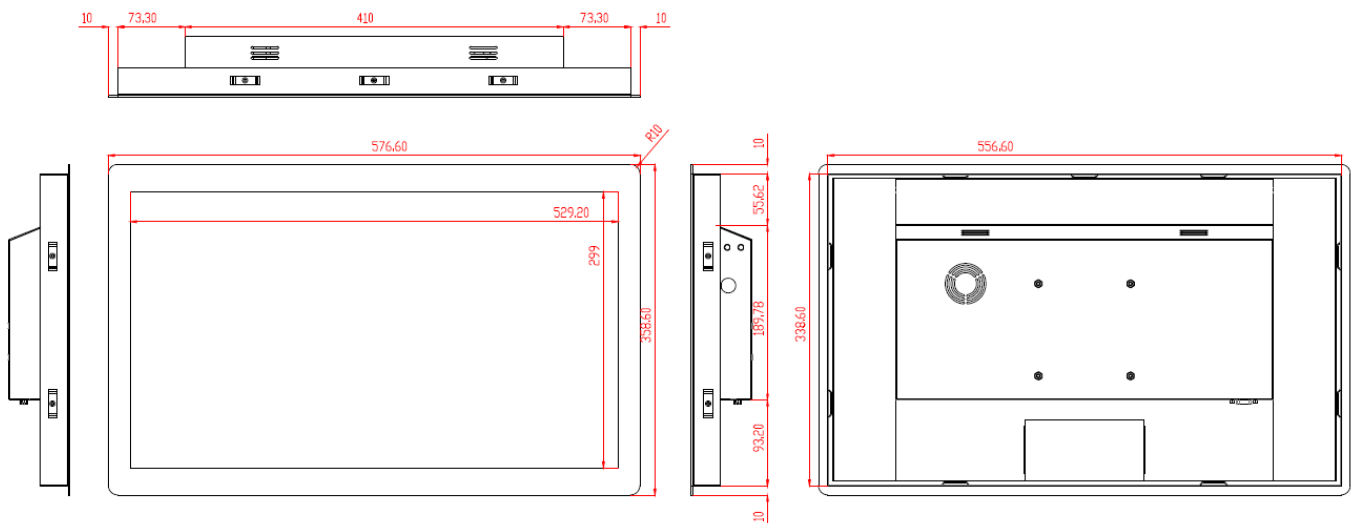

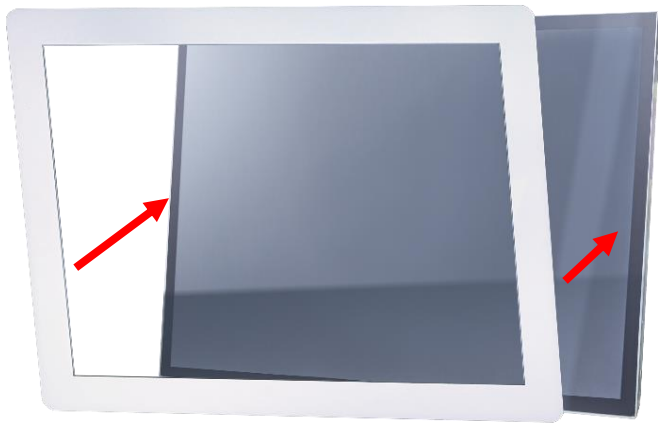

Step 1: Assemble the front module with the screen body. (This step is pre-assembled at the factory.)

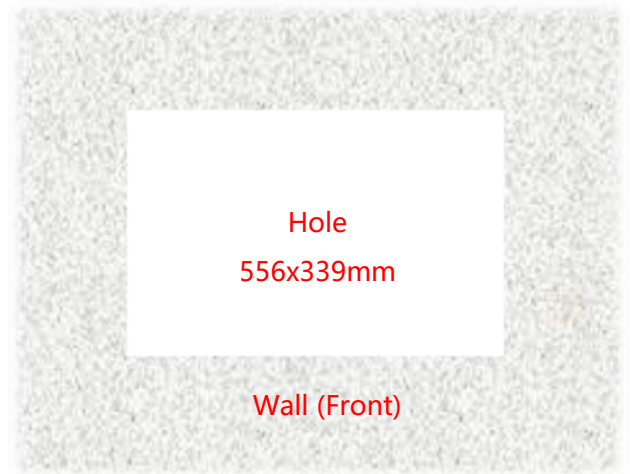

Step 2: Insert the screen from the front into the pre-cut opening.

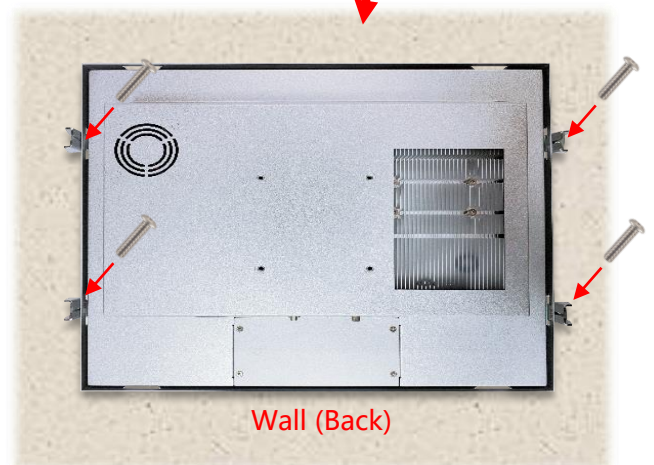

Step 3: Attach the clips from the back and secure with screws. (Up to 9 clips can be installed as needed or per positional limitations.)

### Desktop Stand (Option)

Item	B Stand	Part No.	DST-0B002/DST-1B002
Mounting Pattern	100x100 / 75x75 mm	Dimension (WxHxD)	203x275x227 mm
Material	Steel/Plastic/Aluminum	Net Weight	1.8 KG
Tilt (Hinge)	-2° ~ +180°	Support Max. Weight	15 KG



Item	Z Stand	Part No.	DST-0BZ01/DST-1BZ01
Mounting Pattern	100x100 / 75x75 mm	Dimension (WxHxD)	190x240x41.6
Material	SECC	Net Weight	2.6 KG
Tilt (Hinge)	±360°	Support Max. Weight	15 KG

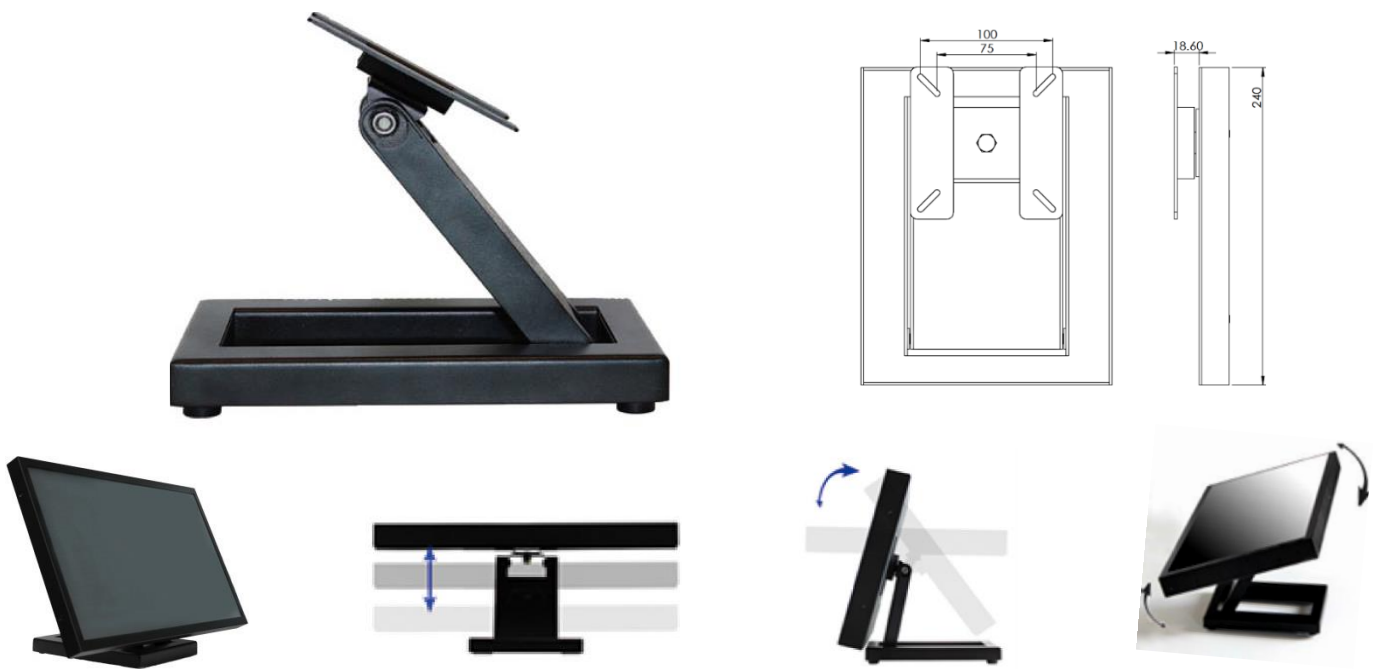

## Wall Mount Bracket (Option)

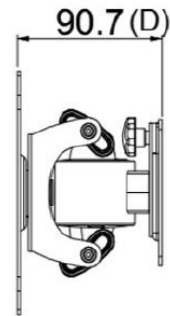
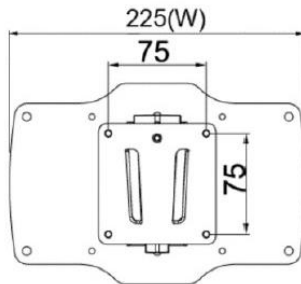
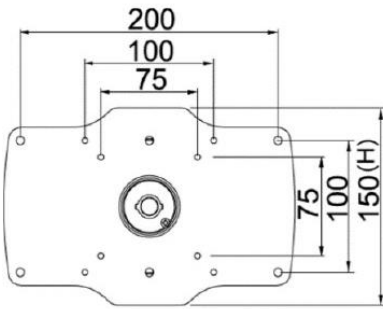
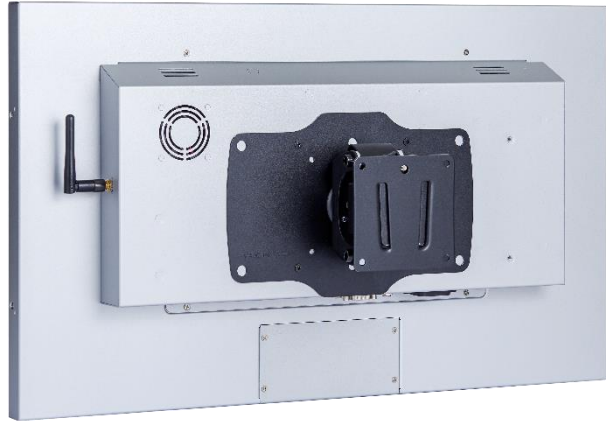

## Packing Information



Unit Carton Size	<b>665x160x510 mm</b>
Unit N. Weight	<b>≤6.1 KG</b>
Unit G. Weight	<b>≤8.1 KG</b>
Units per Pallet	<b>30 units</b>
Pallet Size	<b>120x100x171 CM</b>

## Physical Specifications

Dimension	<b>546x329x63(±2)mm</b>	Net Weight	<b>≤6.1 KG</b>
VESA Mounting	<b>100x100 mm</b>	Gross Weight	<b>≤8.1 KG</b>

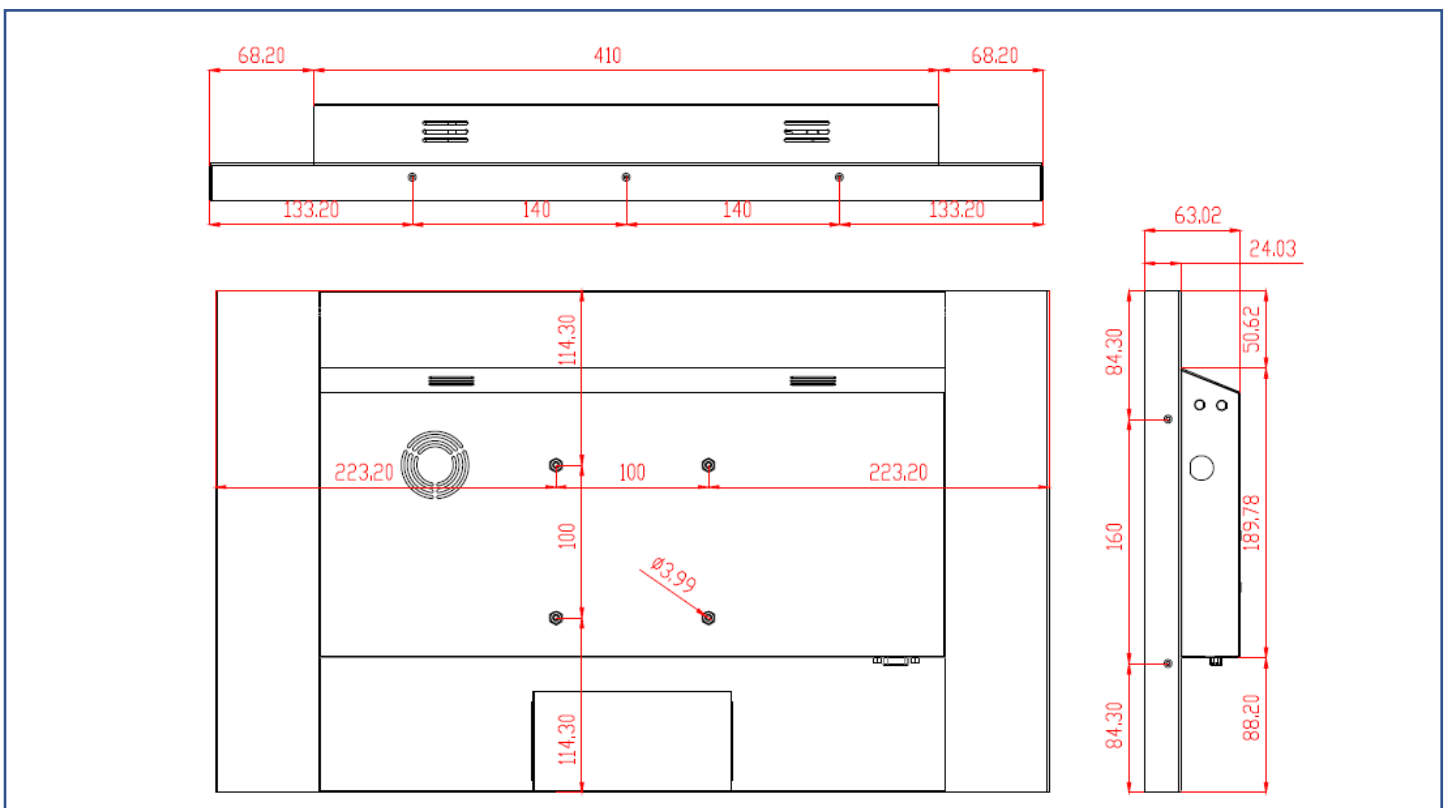
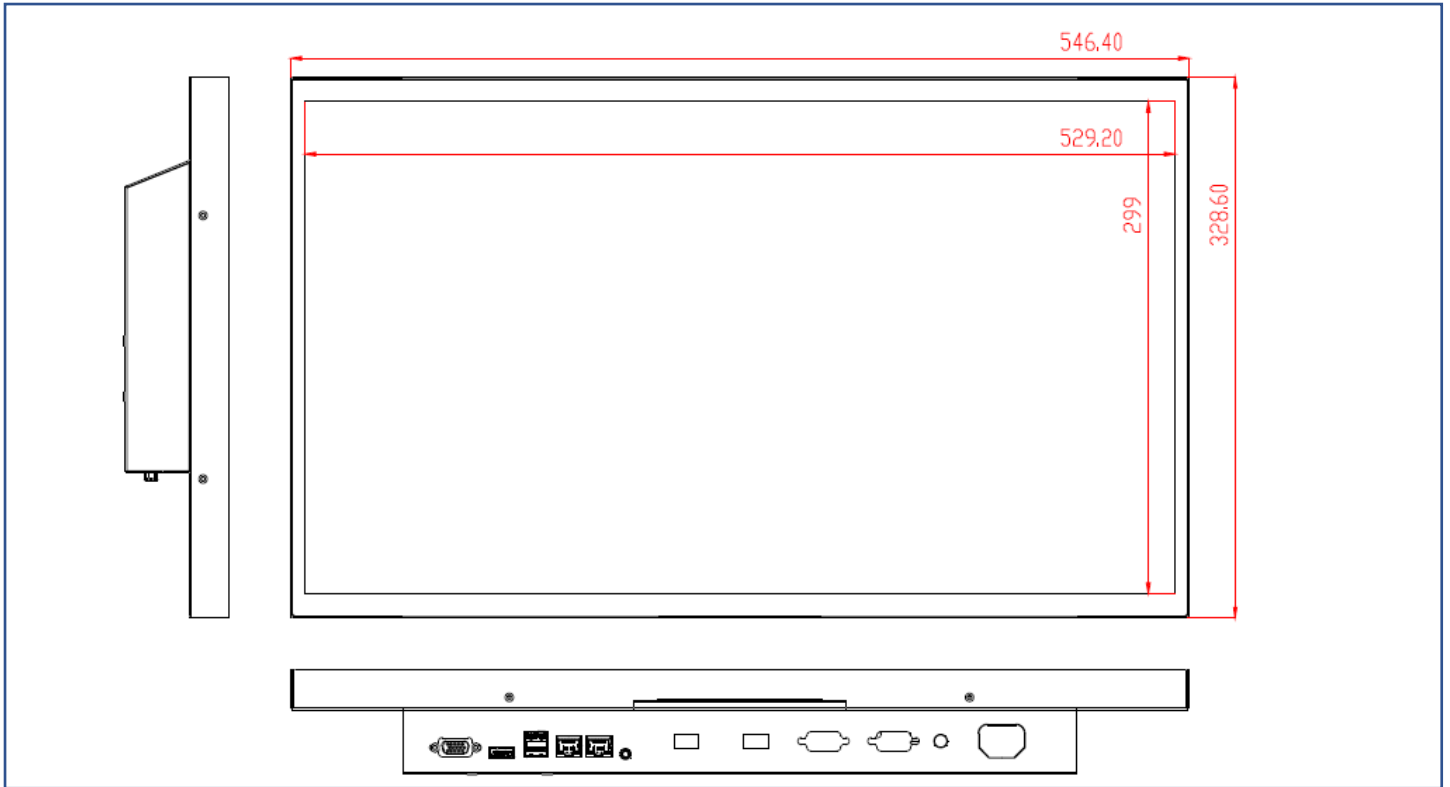



## Cosmetic Inspection Standard

Display Area Allowance			
Defect description	Defective Specifications	Allowance	Remarks
Dot Defect (including dark dot, particles, bubbles, pits, dust, foreign matter)	$D \leq 0.2\text{mm}$	Ignored	D=Diameter
	$0.2 < D \leq 0.7\text{mm}$	$N \leq 5$	N=Quantity
	$0.7 < D \leq 1\text{mm}$	$N \leq 3$	
	$D > 1\text{mm}$	$N \leq 0$	
Linear Defect (including scratches, fluff, particles)	$W \leq 0.15\text{mm}$	Ignored	W=Width
	$0.15 < W \leq 0.5\text{mm}, L \leq 15\text{mm}$	$N \leq 2$	L=Length
	$W > 0.5\text{mm}$ or $L > 15\text{mm}$	NG	

\* Visual inspection distance: 60cm, 90 degree (same for front/side/back)

Front Appearance Allowance (Including Coating)			
Defect description	Defective Specifications	Allowance	Remarks
Dot Defect (including particles, bubbles, pits...etc.)	$D \leq 0.7\text{mm}$	Ignored	D=Diameter
	$0.7 < D \leq 1.5\text{mm}$	$N \leq 3$	N=Quantity
	$D > 1.5\text{mm}$	$N \leq 0$	
Linear Defect (including scratches, fluff, particles)	$W \leq 0.2\text{mm}, L \leq 15\text{mm}$	Ignored	W=Width, L=Length
	$0.2 < W \leq 0.7\text{mm}, L \leq 15\text{mm}$	$N \leq 1$	
	$W > 0.7\text{mm}$ or $L > 15\text{mm}$	NG	

Side / Back Appearance Allowance (Including Coating)			
Defect description	Defective Specifications	Allowance	Remarks
Dot Defect (including particles, bubbles, pits...etc.)	$D \leq 1.5\text{mm}$	Ignored	D=Diameter
	$1.5 < D \leq 3\text{mm}$	$N \leq 8$	N=Quantity
	$D > 3\text{mm}$	$N \leq 2$	
Linear Defect (including scratches, fluff, particles)	$W \leq 0.8\text{mm}, L \leq 15\text{mm}$	Ignored	W=Width, L=Length
	$0.8 < W \leq 1.5\text{mm}, L \leq 15\text{mm}$	$N \leq 5$	
	$W > 1.5\text{mm}$ or $L > 15\text{mm}$	NG	

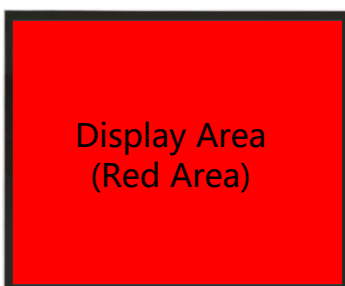

Display Area  
(Red Area)



Front Appearance (Red Area)



Back Appearance