

# Product Specifications

<b>Customer</b>	
<b>Model Name</b>	<b>NTWP170-1 V511</b>
<b>Model Number</b>	<b>NTWP170<u>XXSXX</u>-GI<u>XXXXXX</u>-<u>XXXX</u>-511</b>

\* X = A~Z, 0~9 (Depends on Options.)



Records of Revision			
Vision	Modifying	Old Description	New Description
v2209.1	Preliminary Specification		
v2209.2	Add Stylus Pen Option		
v2209.3	Upgrade Display Specifications	Panel Type: TN Operating Temp.: 0~50°C Viewing Angles: 170°/160° Response Time: 5 msec	Panel Type: IAV Operating Temp: 0~60°C Viewing Angles: 178°/178° Response Time: 25 msec
<b>v2209.4</b>	<b>New trademark released</b>		

## Features

- ★ 17 inch, 1280x1024 Resolution
- ★ IAV type, Wide Viewing Angle Technology (178°/178°)
- ★ Intel® 11th Generation Core i Series CPU
- ★ DDR4 8G RAM (Max. 32G)
- ★ Narrow Bezel, True Flat Projected Capacitive Touch Screen
- ★ 7H Hardness Tempered Cover Glass
- ★ 10 points Multi-touch, Supports NEXTECH Dedicated Stylus
- ★ Metal Cabinet with Diverse Combine Options
- ★ Made in Taiwan, 3 Years Warranty
- ★ Optional High Brightness 1500nits, for Outdoor Environment
- ★ Optional AG Coating/Antibacterial/Privacy Filter Surface Treatment

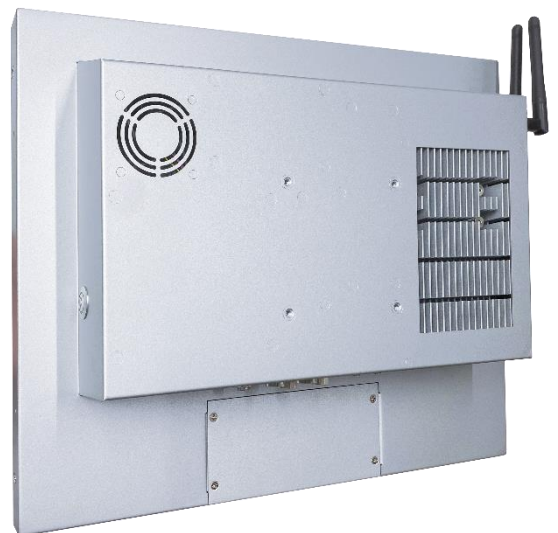

Desktop Stand



Wall Mounting



Open-frame Bracket



Panel Mount

## System Specifications

CPU	Intel® 11th Generation Core i Series CPU
Memory	DDR4 SO-DIMM x2, Max. 64G
Storage	Ultra-Fast M.2 with PCIe Gen3 x2, SATA 6Gb/s x1
GPU	Intel® UHD Graphics
Sound Chip	Realtek Audio CODEC
Network	Intel Gigabit LAN, RJ45 ports x2

## Display Specifications

Screen Diagonal	432mm (17.0 inch)	Display Mode	IAV Type, Normally Black
Display Area	337.9x270.3 mm	Backlight Unit	LED (white LED)
Resolution	1280x1024	Viewing Angle (L/R, U/D)	178°/178°
Contrast Ratio	1000:1	Response Time	25 msec.
Display Ratio	4:3	Backlight Lifetime	>50,000 Hours
Support Colors	16.7M Colors	Operating Temp.	0~60°C
Pixel Pitch	264x264 um	Storage Temp.	-20~60°C

## Display Options

Brightness			
	Brightness	Environment	Model Name
Standard	250nits	General (Indoor)	NTWP170NXSXX-GIXXXXX-XXXX-511
Option 1	1000nits	Outdoor Environment	NTWP170AXSXX-GIXXXXX-XXXX-511
Option 2	1500nits	Sunlight Readable	NTWP170FXSXX-GIXXXXX-XXXX-511

## Touch Options

Projected Capacitive			
Model Name	NTWP170XPSXX-GIXXXXX-XXXX-511		
Touch Technology	Projected Capacitive	Thickness of Cover Lens	2.0±0.2mm
Allowed Touch Points	10 points	Hardness of Cover Lens	7H
Transparency	≥87%	IK Ratings	IK07
Accuracy	99.00%		

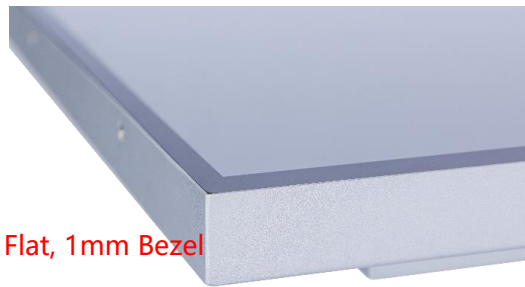

\* True Flat, 1mm Bezel

Non-Touch	
Model Name	NTWP170X0SXX-GIXXXXX-XXXX-511

Surface Treatment		
	Description	Model Name
<b>Standard</b>	<b>(none)</b>	<b>NTWP170XXS00-GIXXXXX-XXXX-511</b>
Option 1	Anti-Glare Coating	NTWP170XXSGG-GIXXXXX-XXXX-511
Option 2	Antibacterial (AB Film)	NTWP170XXSAB-GIXXXXX-XXXX-511
Option 3	Anti-Spy (AS Film)	NTWP170XXSXF-GIXXXXX-XXXX-511

Passive Stylus Pen (Option)	
Technology	Passive High Sensitive Knitted Wire Mesh Fiber Tip
Size of tip	6mm
Magnetic Attachment	Yes

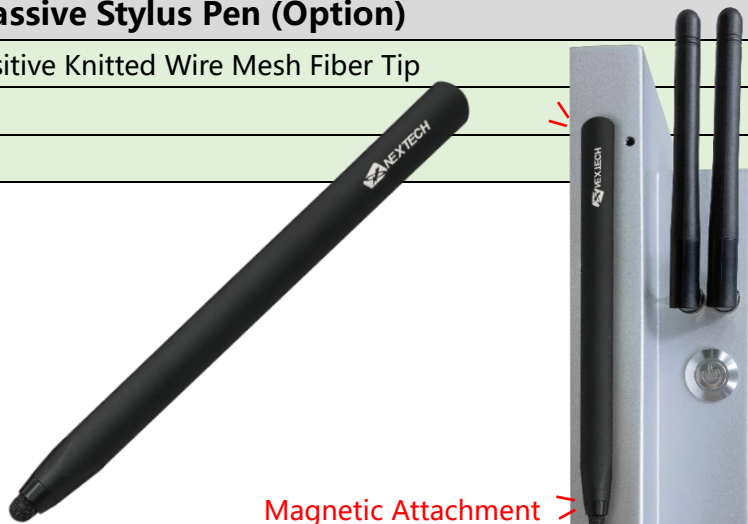

Magnetic Attachment

## System Options

CPU		
	Item	Model Name
<b>Standard</b>	<b>Intel® Core i3-1115G4E</b>	<b>NTWP170XXSXX-GI31XXX-XXXX-511</b>
Option 1	Intel® Core i5-1135G7	NTWP170XXSXX-GI51XXX-XXXX-511
Option 2	Intel® Core i7-1165G7	NTWP170XXSXX-GI71XXX-XXXX-511

Memory		
	Item	Model Name
<b>Standard</b>	<b>DDR4 SO-DIMM 8G</b>	<b>NTWP170XXSXX-GIXX8XX-XXXX-511</b>
Option 1	DDR4 SO-DIMM 16G	NTWP170XXSXX-GIXXAXX-XXXX-511
Option 2	DDR4 SO-DIMM 32G	NTWP170XXSXX-GIXXBXX-XXXX-511
Option 3	DDR4 SO-DIMM 64G	NTWP170XXSXX-GIXXCXX-XXXX-511

Storage		
	Item	Model Name
<b>Standard</b>	<b>SSD 128G</b>	<b>NTWP170XXSXX-GIXXXS1-XXXX-511</b>
Option 1	SSD 256G	NTWP170XXSXX-GIXXXS2-XXXX-511
Option 2	SSD 512G	NTWP170XXSXX-GIXXXS3-XXXX-511
Option 3	SATA HDD 1T	NTWP170XXSXX-GIXXXH1-XXXX-511
Option 4	SSD 128G + SATA HDD 1T	NTWP170XXSXX-GIXXXSH-XXXX-511

Material of Cabinet		
	Description	Model Name
<b>Standard</b>	<b>SECC</b>	<b>NTWP170XXSXX-GIXXXXXX-SXXX-511</b>
Option 1	Stainless Steel	NTWP170XXSXX-GIXXXXXX-LXXX-511
Option 2	Aluminum	NTWP170XXSXX-GIXXXXXX-AXXX-511

## System Options (Continued)

Color of Cabinet		
	Description	Model Name
<b>Standard</b>	<b>Silver</b>	<b>NTWP170XXSXX-GIXXXXXX-<u>X</u>SXX-511</b>
Option 1	White	NTWP170XXSXX-GIXXXXXX- <u>X</u> WXX-511
Option 2	Black	NTWP170XXSXX-GIXXXXXX- <u>X</u> BXX-511
Options	Other Colors	NTWP170XXSXX-GIXXXXXX- <u>X</u> XXX-511

\* X = A~Z, 0~9 (Depends on Color)

Cooling Fan		
	Description	Model Name
<b>Standard</b>	<b>Fanless</b>	<b>NTWP170XXSXX-GIXXXXXX-<u>XX</u>0X-511</b>
Option	7 Blades/4000r.p.m/28.3dB	NTWP170XXSXX-GIXXXXXX- <u>XX</u> FX-511

Power Input		
	Description	Model Name
<b>Standard</b>	<b>9~24VDC-in, with AC/DC Adapter</b>	<b>NTWP170XXSXX-GIXXXXXX-<u>XXX</u>5-511</b>
Option	100~240VAC, C14 AC Power Socket	NTWP170XXSXX-GIXXXXXX- <u>XXX</u> A-511



DC-in



AC-in

### Input /Output System

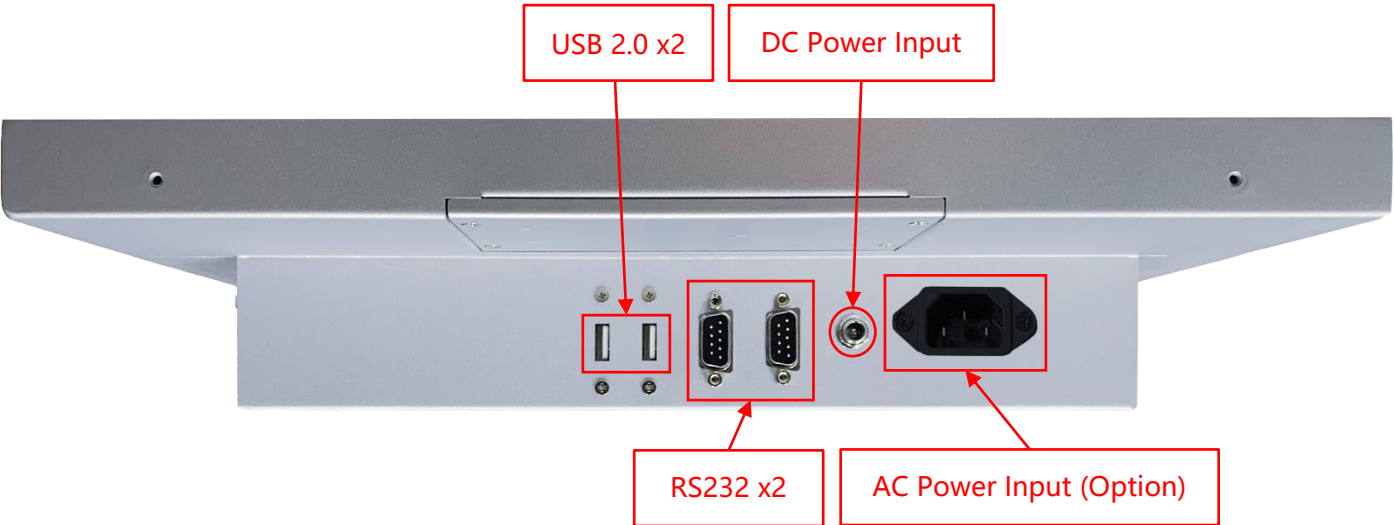
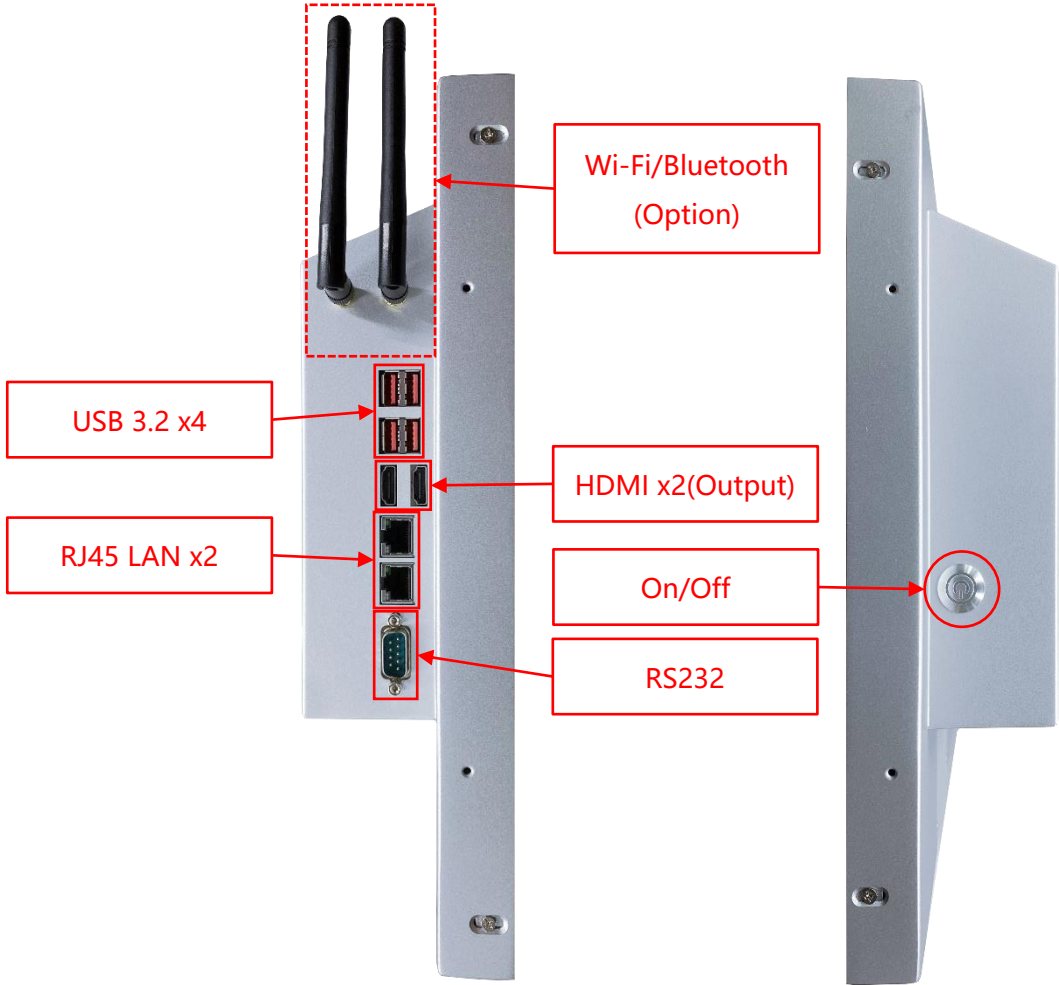



# Nextech WP Series 17" All-in-one Touch PC

**NTWP170-1 V511**

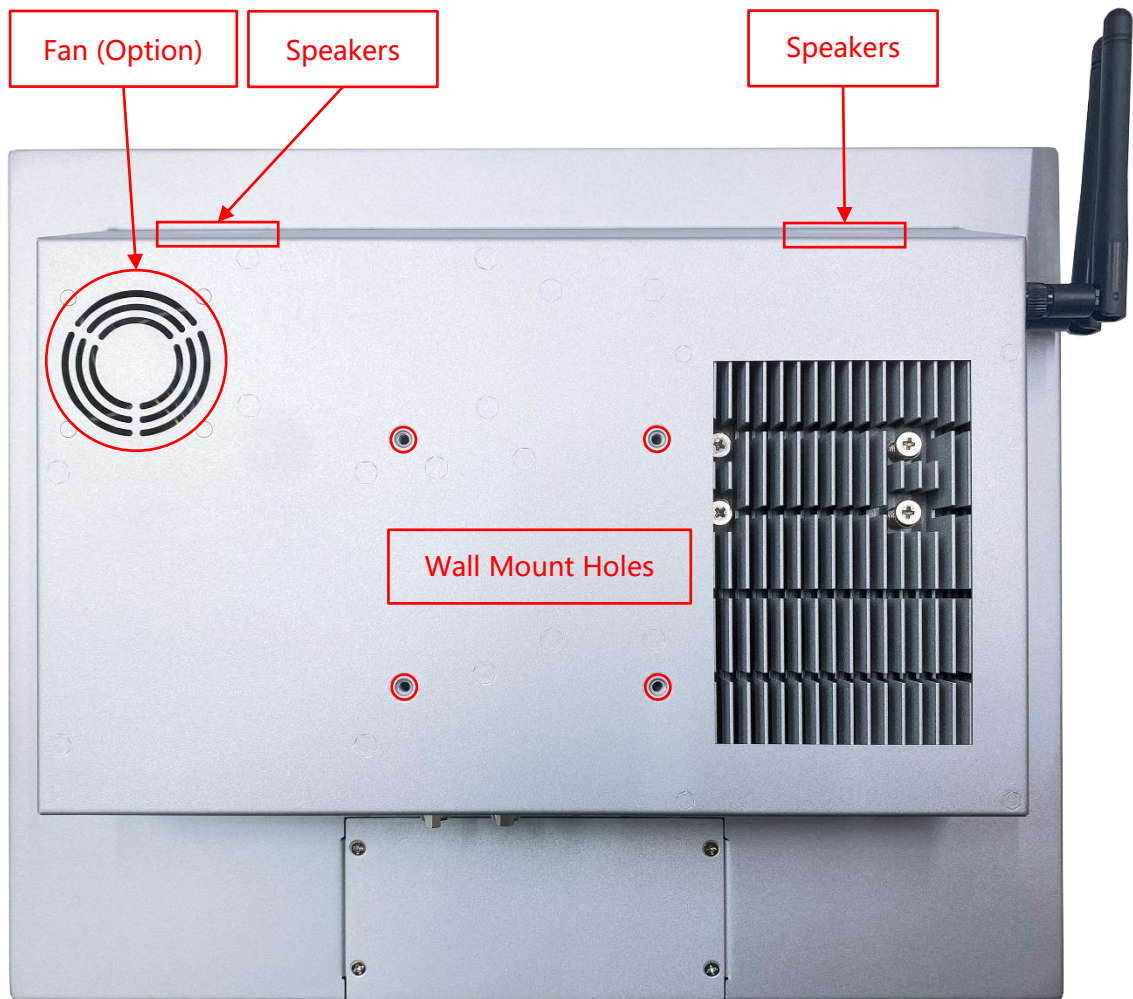

Input / Output	Connectors	Input / Output	Connectors
HDMI (Output)	2	Speakers	2W x2
USB 3.2 Gen2	4	DC Power Input	1
USB 2.0	2	AC Power Input	Option
RS232	3	Wi-Fi/Bluetooth & Antenna	Option
LAN (RJ45)	2		



## Front Cover (Option)

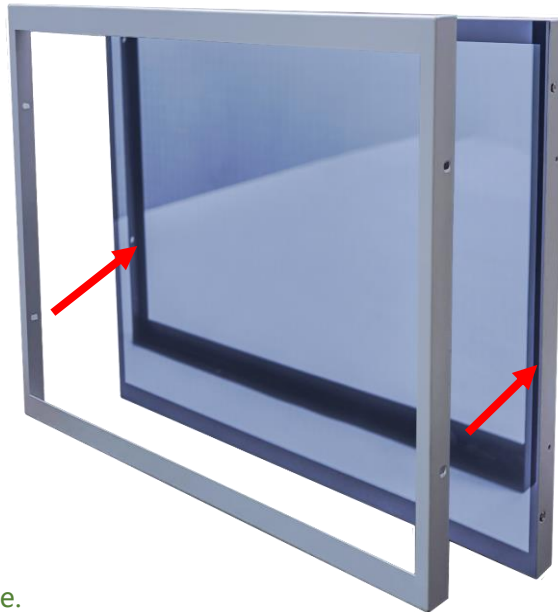

The standard **NTWP170** is true flat surface.

To protect the corners of the touch screen, the Front Cover can be added.



The watertight gasket can be added between the Front Cover and **NTWP170**.

It complies **IP65** on front.

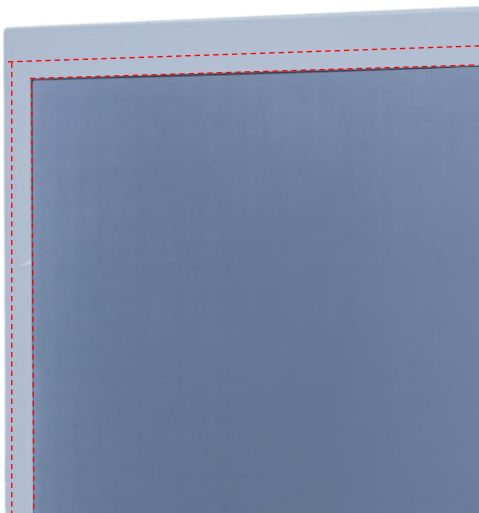



**Panel Mount Kits (Option)**



**Dimension for Installing with Panel Mount Kits**

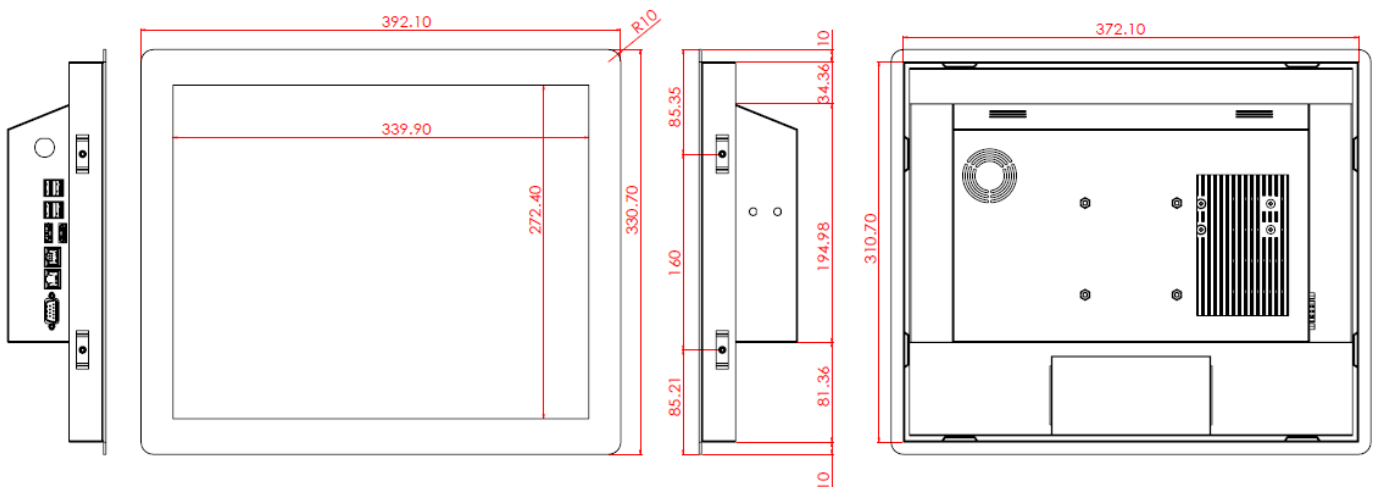
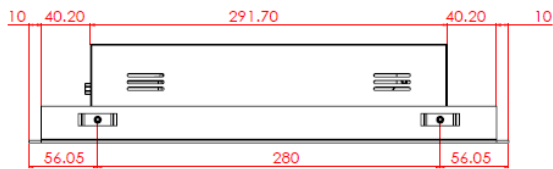

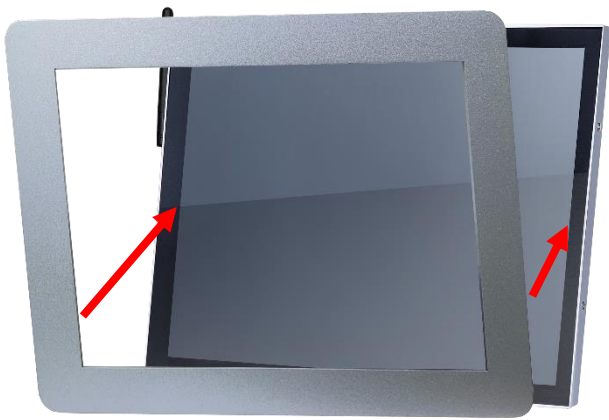

Step 1: Assemble the front module with the screen body. (This step is pre-assembled at the factory.)

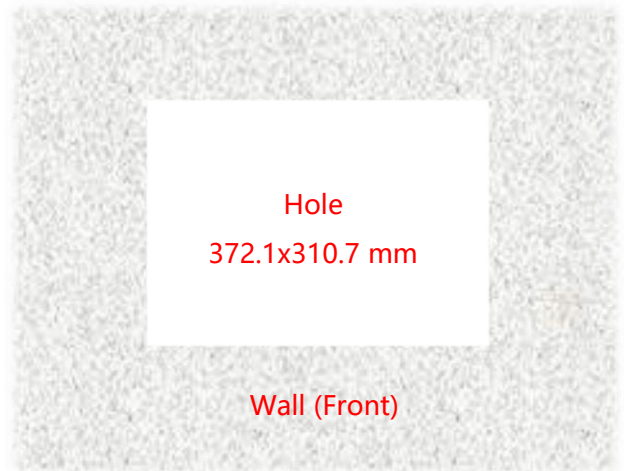

Step 2: Insert the screen from the front into the pre-cut opening.

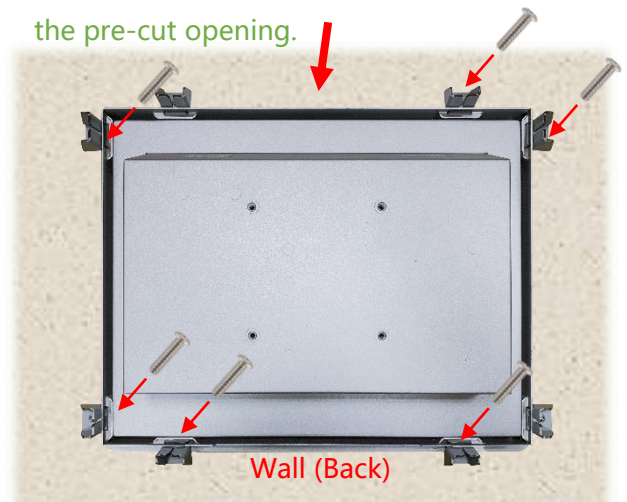
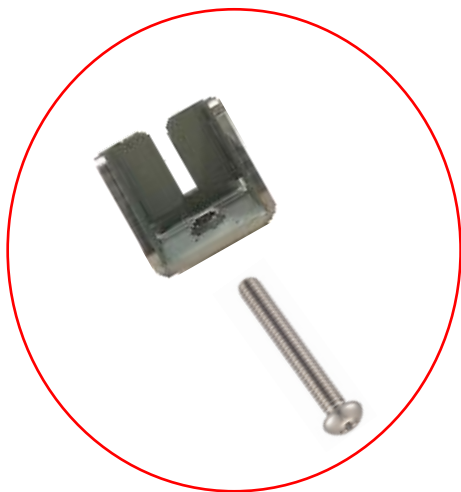

Step 3: Attach the clips from the back and secure with screws. (Up to 8 clips can be installed as needed or per positional limitations.)

### Desktop Stand (Option)

Item	B Stand	Part No.	DST-0B002/DST-1B002
Mounting Pattern	100x100 / 75x75 mm	Dimension (WxHxD)	203x275x227 mm
Material	Steel/Plastic/Aluminum	Net Weight	1.8 KG
Tilt (Hinge)	-2° ~ +180°	Support Max. Weight	15 KG



Item	Z Stand	Part No.	DST-0BZ01/DST-1BZ01
Mounting Pattern	100x100 / 75x75 mm	Dimension (WxHxD)	190x240x41.6
Material	SECC	Net Weight	2.6 KG
Tilt (Hinge)	±360°	Support Max. Weight	15 KG

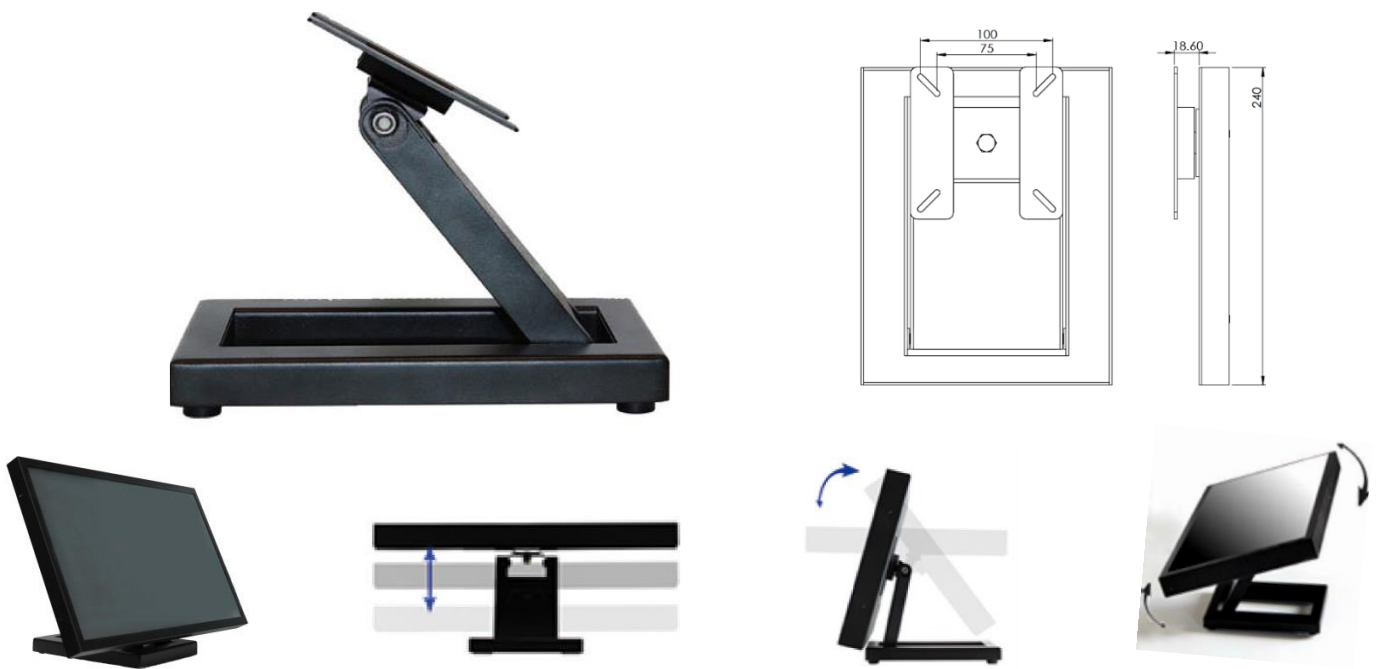

**Wall Mount Bracket (Option)**

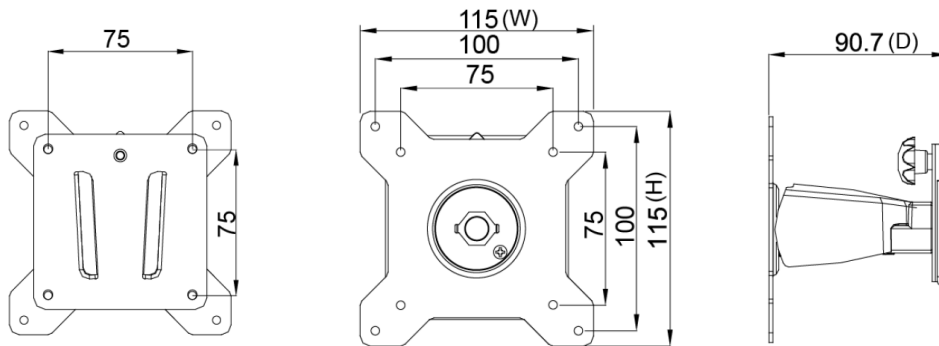
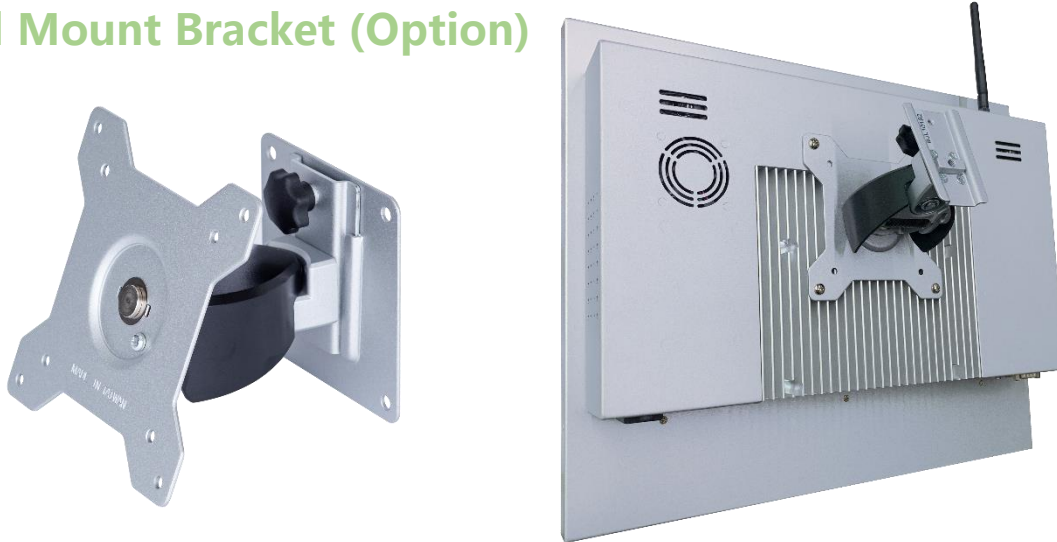

**Packing Information**

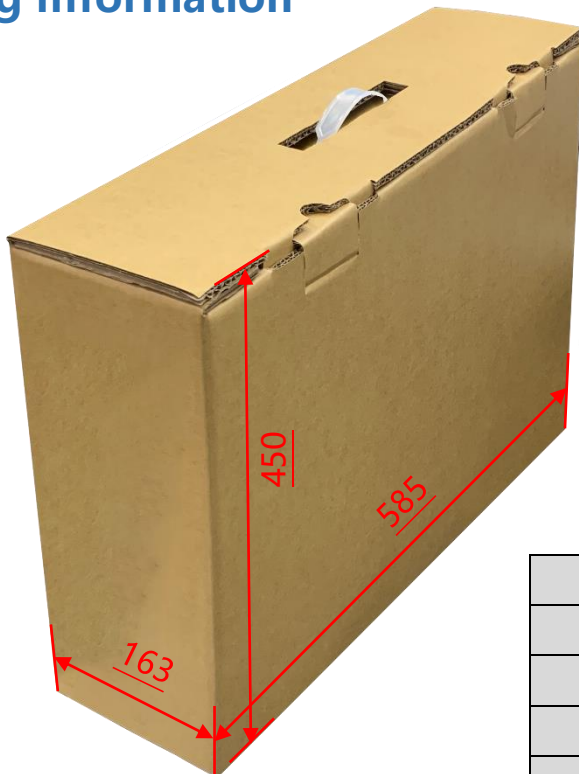

Unit Carton Size	<b>585x163x450 mm</b>
Unit N. Weight	<b>≤4.1 KG</b>
Unit G. Weight	<b>≤5.9 KG</b>
Units per Pallet	<b>36 units</b>
Pallet Size	<b>120x100x147 CM</b>

## Physical Specifications

Dimension	<b>362x301x78(±2)mm (W/O Antenna)</b>	Net Weight	<b>≤4.1 KG</b>
VESA Mounting	<b>75x75 mm</b>	Gross Weight	<b>≤5.9 KG</b>

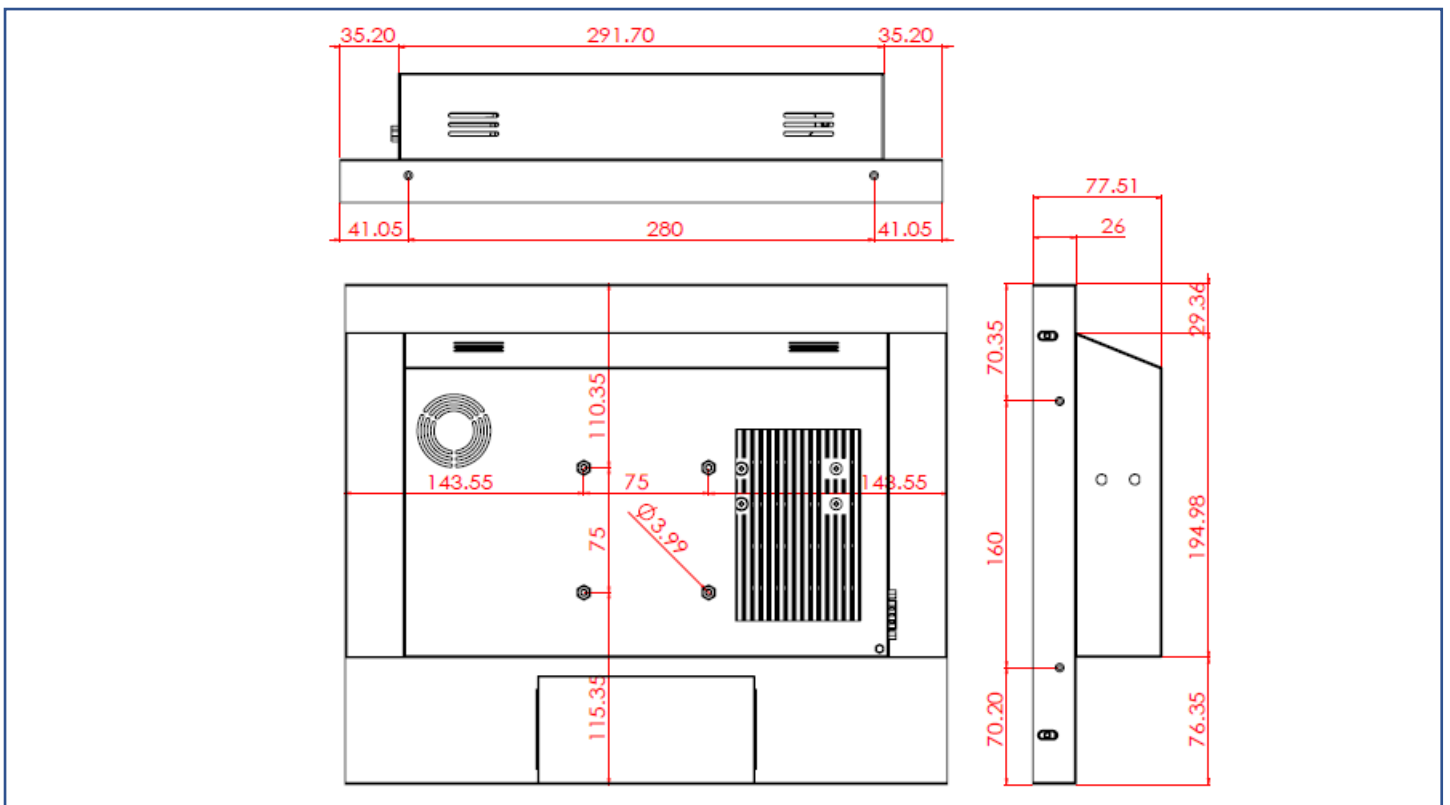
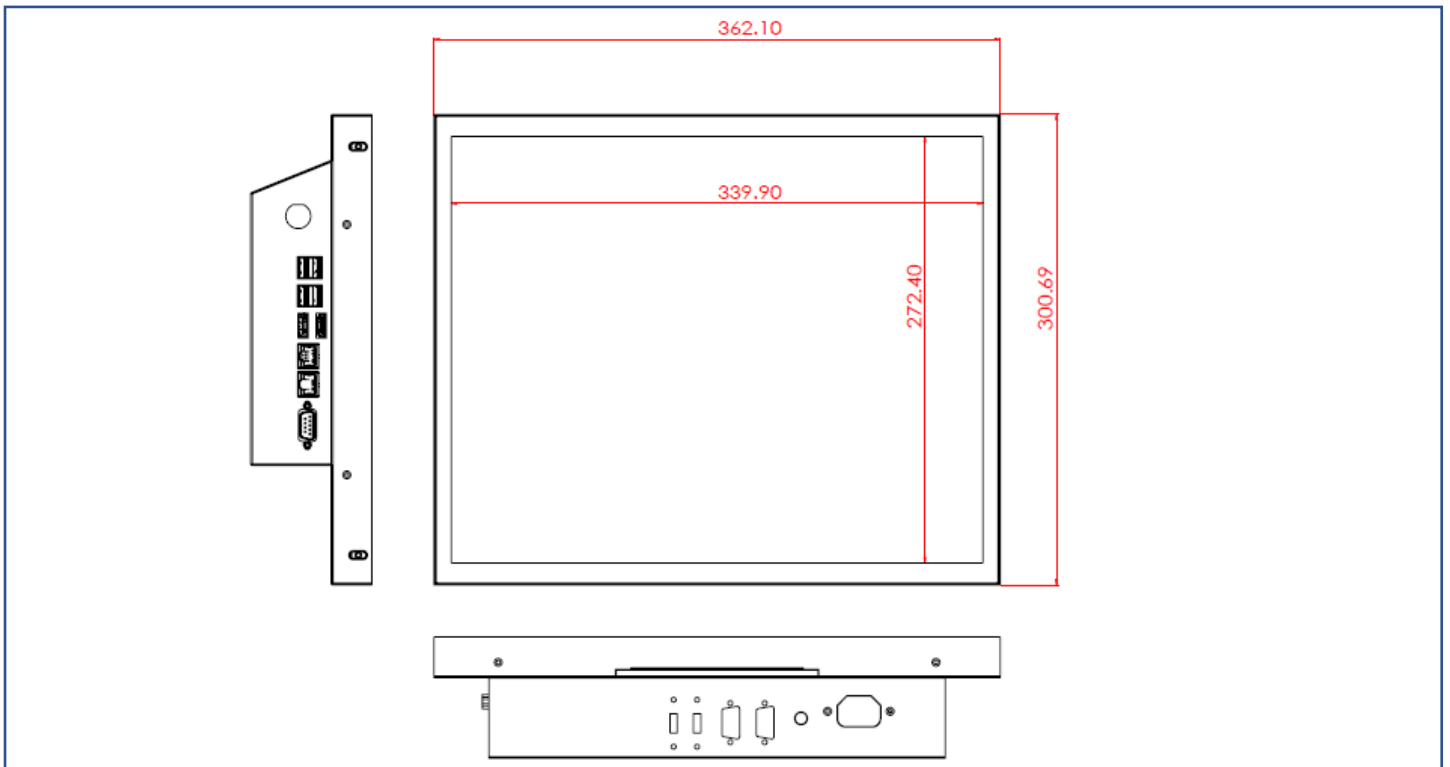



## Cosmetic Inspection Standard

Display Area Allowance			
Defect description	Defective Specifications	Allowance	Remarks
Dot Defect (including dark dot, particles, bubbles, pits, dust, foreign matter)	$D \leq 0.2\text{mm}$	Ignored	D=Diameter
	$0.2 < D \leq 0.7\text{mm}$	$N \leq 5$	N=Quantity
	$0.7 < D \leq 1\text{mm}$	$N \leq 3$	
	$D > 1\text{mm}$	$N \leq 0$	
Linear Defect (including scratches, fluff, particles)	$W \leq 0.15\text{mm}$	Ignored	W=Width
	$0.15 < W \leq 0.5\text{mm}, L \leq 15\text{mm}$	$N \leq 2$	L=Length
	$W > 0.5\text{mm}$ or $L > 15\text{mm}$	NG	

\* Visual inspection distance: 60cm, 90 degree (same for front/side/back)

Front Appearance Allowance (Including Coating)			
Defect description	Defective Specifications	Allowance	Remarks
Dot Defect (including particles, bubbles, pits...etc.)	$D \leq 0.7\text{mm}$	Ignored	D=Diameter
	$0.7 < D \leq 1.5\text{mm}$	$N \leq 3$	N=Quantity
	$D > 1.5\text{mm}$	$N \leq 0$	
Linear Defect (including scratches, fluff, particles)	$W \leq 0.2\text{mm}, L \leq 15\text{mm}$	Ignored	W=Width, L=Length
	$0.2 < W \leq 0.7\text{mm}, L \leq 15\text{mm}$	$N \leq 1$	
	$W > 0.7\text{mm}$ or $L > 15\text{mm}$	NG	

Side / Back Appearance Allowance (Including Coating)			
Defect description	Defective Specifications	Allowance	Remarks
Dot Defect (including particles, bubbles, pits...etc.)	$D \leq 1.5\text{mm}$	Ignored	D=Diameter
	$1.5 < D \leq 3\text{mm}$	$N \leq 8$	N=Quantity
	$D > 3\text{mm}$	$N \leq 2$	
Linear Defect (including scratches, fluff, particles)	$W \leq 0.8\text{mm}, L \leq 15\text{mm}$	Ignored	W=Width, L=Length
	$0.8 < W \leq 1.5\text{mm}, L \leq 15\text{mm}$	$N \leq 5$	
	$W > 1.5\text{mm}$ or $L > 15\text{mm}$	NG	

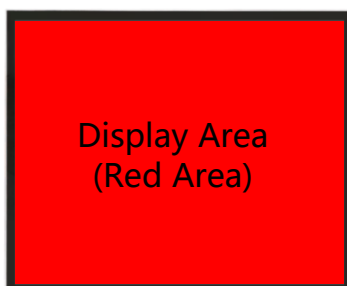

Display Area  
(Red Area)



Front Appearance (Red Area)



Back Appearance