

Product Specifications

Customer	
Model Name	NTWP133 V511
Model Number	NTWP133 <u>XXSXX</u>-GI<u>XXXXXX</u>-<u>XX</u>05-511

* X = A~Z, 0~9 (Depends on Options.)



Records of Revision			
Vision	Modifying	Old Description	New Description
v2208.1	Preliminary Specifications		
v2208.2	Add Stylus Pen Option		
v2208.3	New trademark released		

Features

- ★ 13.3 inch Industrial Grade Panel, 1920x1080 (FHD) Resolution
- ★ AHVA Wide Viewing Angle Technology , 178°/178°
- ★ Operating Temperature Range -20~70°C
- ★ Intel® 11th Generation Core i Series CPU
- ★ DDR4 8G RAM (Max. 64G)
- ★ Narrow Bezel, True Flat Projected Capacitive Touch Screen
- ★ 7H Hardness Tempered Cover Glass
- ★ 10 points Multi-touch, Supports NEXTECH Dedicated Stylus
- ★ Metal Cabinet with Diverse Combine Options
- ★ Made in Taiwan, 3 Years Warranty, Designed for Harsh Environments
- ★ Optional High Brightness 1500nits, for Outdoor Environment
- ★ Optional AG Coating/Antibacterial/Privacy Filter Surface Treatment



PSE



BSMI



Desktop Stand



Wall Mounting



Open-frame Bracket



Panel Mount

System Specifications

CPU	Intel® 11th Generation Core i Series CPU
Memory	DDR4 SO-DIMM x2, Max. 64G
Storage	Ultra-Fast M.2 with PCIe Gen3 x2, SATA 6Gb/s x1
GPU	Intel® UHD Graphics
Sound Chip	Realtek Audio CODEC
Network	Intel Gigabit LAN, RJ45 ports x2

Display Specifications

Screen Diagonal	13.3 inch	Display Mode	AHVA Mode
Display Area	293.47x165.07 mm	Backlight Unit	LED (white LED)
Resolution	1920x1080 (FHD)	Viewing Angle (L/R, U/D)	178°/178° (CR=10)
Contrast Ratio	800:1	Response Time	25 msec.
Display Ratio	16:9	Backlight Lifetime	>50,000 Hours
Support Colors	16.7M Colors	Operating Temp.	-20~70°C
Pixel Pitch	0.15285x0.15285 mm	Storage Temp.	-20~70°C

Display Options

Brightness			
	Brightness	Environment	Model Name
Standard	400nits	General (Indoor)	NTWP133NXSXX-GIXXXXX-XX05-511
Option 1	1000nits	Outdoor Environment	NTWP133AXSXX-GIXXXXX-XX05-511
Option 2	1500nits	Sunlight Readable	NTWP133FXSXX-GIXXXXX-XX05-511

Touch Options

Projected Capacitive			
Model Name	NTWP133X <u>P</u> SXX-GIXXXXX-XX05-511		
Touch Technology	Projected Capacitive	Thickness of Cover Lens	2.0±0.2mm
Allowed Touch Points	10 points	Hardness of Cover Lens	7H
Transparency	≥87%	IK Ratings	IK07
Accuracy	99.00%		

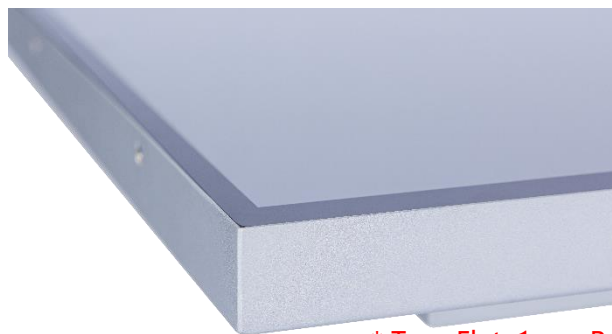

* True Flat, 1mm Bezel

Non-Touch	
Model Name	NTWP133X <u>0</u> SXX-GIXXXXX-XX05-511

Surface Treatment		
	Description	Model Name
Standard	(none)	NTWP133XXS<u>00</u>-GIXXXXX-XX05-511
Option 1	Anti-Glare Coating	NTWP133XXS <u>GG</u> -GIXXXXX-XX05-511
Option 2	Antibacterial (AB Film)	NTWP133XXS <u>AB</u> -GIXXXXX-XX05-511
Option 3	Anti-Spy (AS Film)	NTWP133XXS <u>SF</u> -GIXXXXX-XX05-511

System Options

CPU		
	Item	Model Name
Standard	Intel® Core i3-1115G4E	NTWP133XXSXX-GI31XXX-XX05-511
Option 1	Intel® Core i5-1135G7	NTWP133XXSXX-GI 51 XXX-XX05-511
Option 2	Intel® Core i7-1165G7	NTWP133XXSXX-GI 71 XXX-XX05-511

Memory		
	Item	Model Name
Standard	DDR4 SO-DIMM 8G	NTWP133XXSXX-GIXX8XX-XX05-511
Option 1	DDR4 SO-DIMM 16G	NTWP133XXSXX-GIXX A XX-XX05-511
Option 2	DDR4 SO-DIMM 32G	NTWP133XXSXX-GIXX B XX-XX05-511
Option 3	DDR4 SO-DIMM 64G	NTWP133XXSXX-GIXX C XX-XX05-511

Storage		
	Item	Model Name
Standard	SSD 128G	NTWP133XXSXX-GIXXXS1-XX05-511
Option 1	SSD 256G	NTWP133XXSXX-GIXXX S2 -XX05-511
Option 2	SSD 512G	NTWP133XXSXX-GIXXX S3 -XX05-511
Option 3	SSD 1T	NTWP133XXSXX-GIXXX S4 -XX05-511

System Options (Continued)

Material of Cabinet		
	Description	Model Name
Standard	SECC	NTWP133XXSXX-GIXXXXXX-SX05-511
Option 1	Stainless Steel	NTWP133XXSXX-GIXXXXXX-LX05-511
Option 2	Aluminum	NTWP133XXSXX-GIXXXXXX-AX05-511

Color of Cabinet		
	Description	Model Name
Standard	Silver	NTWP133XXSXX-GIXXXXXX-XS05-511
Option 1	White	NTWP133XXSXX-GIXXXXXX-XW05-511
Option 2	Black	NTWP133XXSXX-GIXXXXXX-XB05-511
Options	Other Colors	NTWP133XXSXX-GIXXXXXX-XX05-511

* X = A~Z, 0~9 (Depends on Color)

Other Options

Wireless Network (Option)	
Spec	Wi-Fi a/b/g/n/ac, Dual Mode Bluetooth 2.1/2.1+EDR,3.0,3.0+HS,4.0 (BLE) (Wi-Fi+BT4.0)

Passive Stylus Pen (Option)	
Technology	Passive High Sensitive Knitted Wire Mesh Fiber Tip
Size of tip	6mm
Magnetic Attachment	Yes



Input /Output System

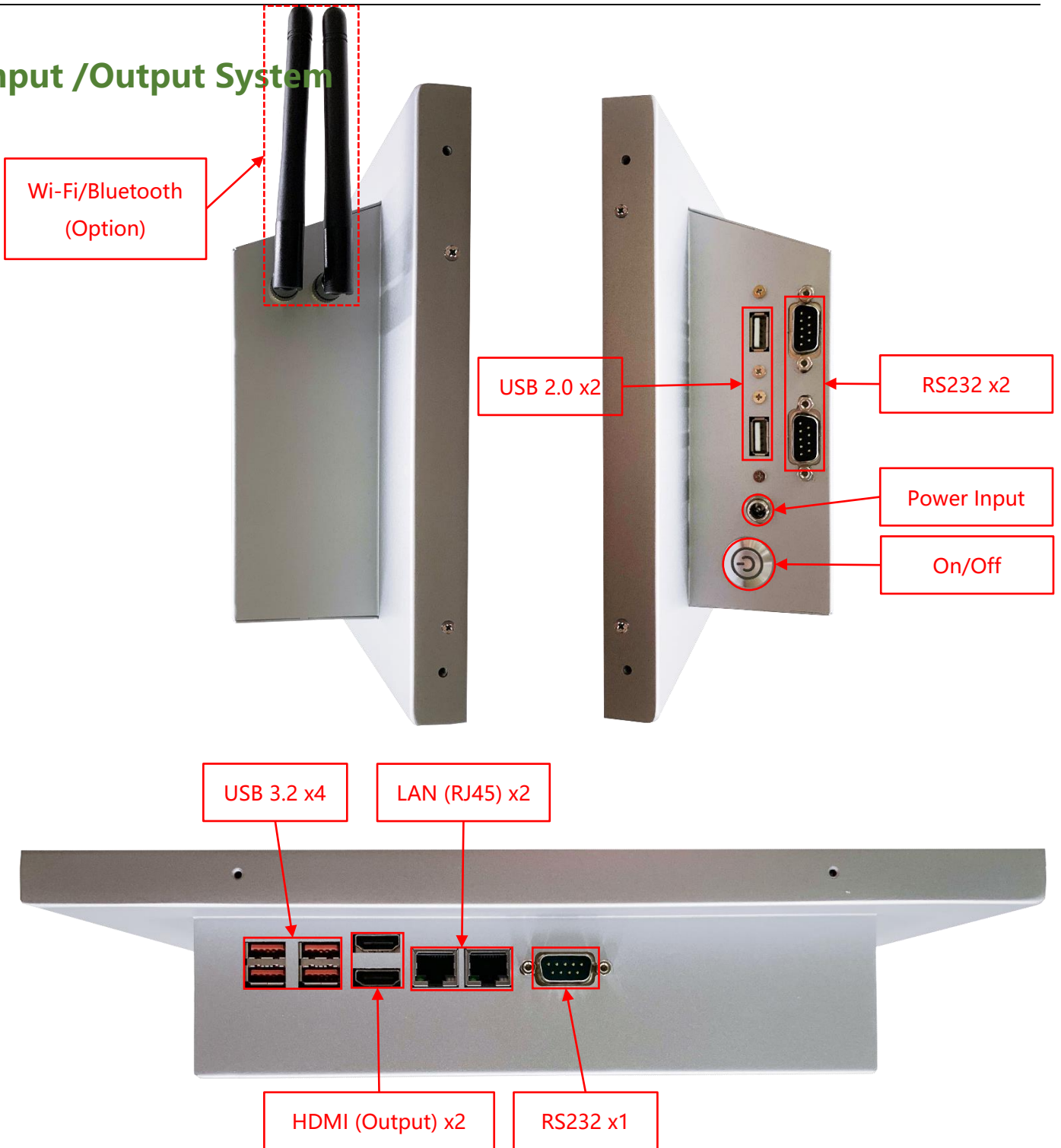

Input / Output	Connectors	Input / Output	Connectors
HDMI (Output)	2	LAN (RJ45)	2
USB 3.2 Gen2	4	Speakers	2W x2
USB 2.0	2	DC Power Input	1
RS232	3	Wi-Fi/Bluetooth & Antenna	Option

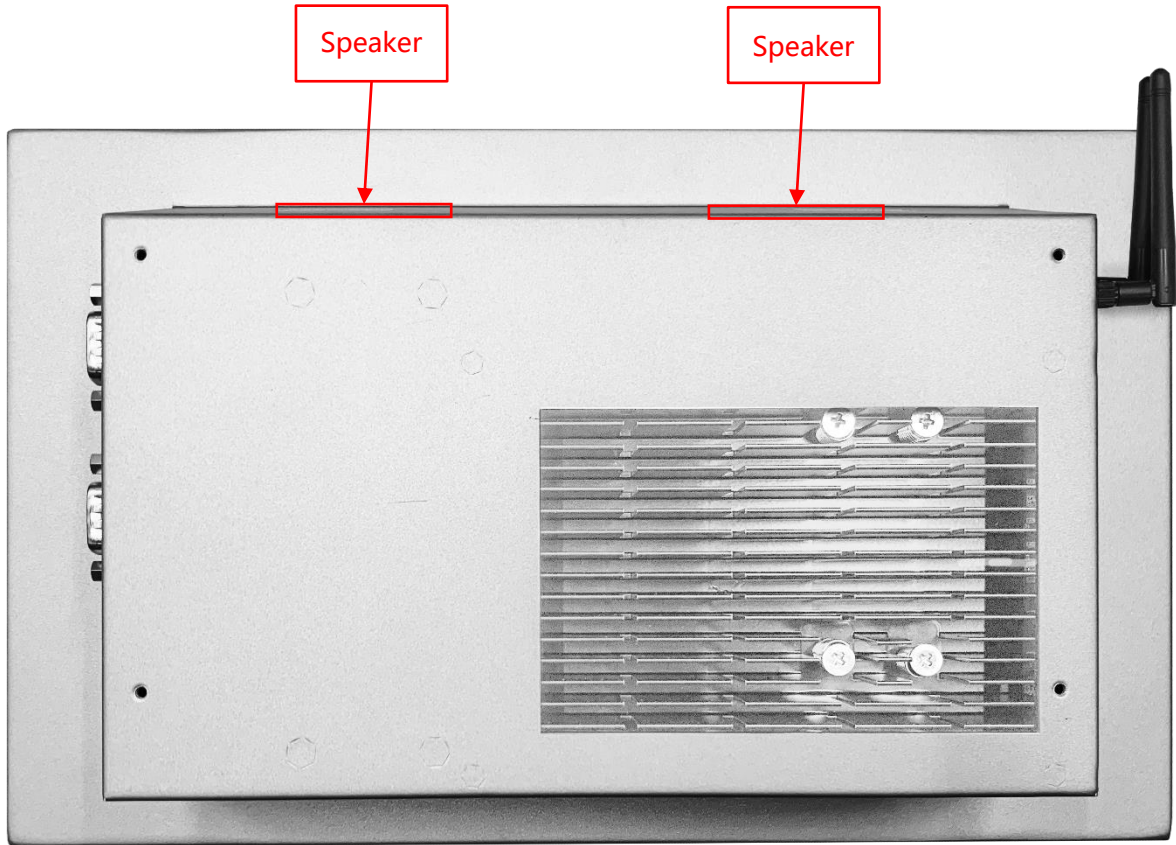

Mounting Plate (Option)

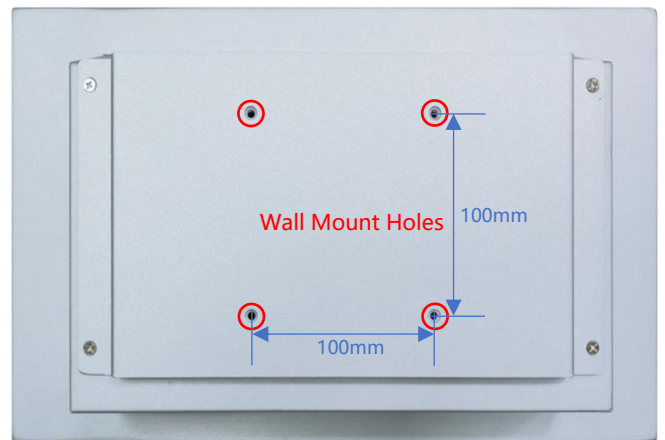
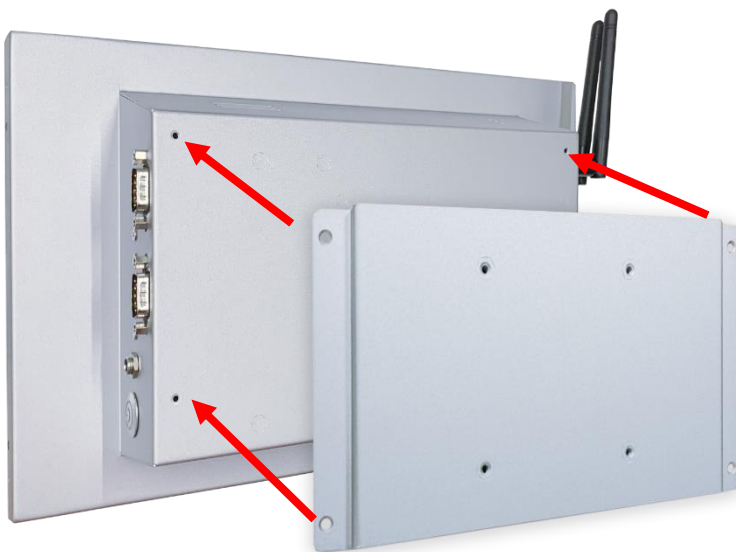

Front Cover (Option)

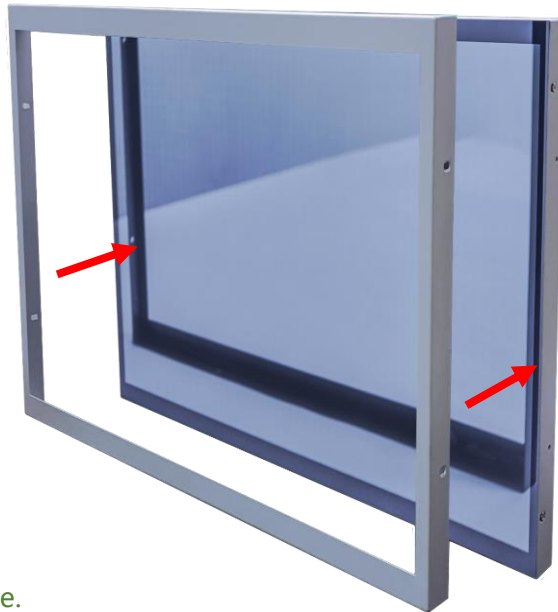

The standard **NTWP133** is true flat surface.

To protect the corners of the touch screen, the Front Cover can be added.



The watertight gasket can be added between the Front Cover and **NTWP133**.

It complies **IP65** on front.

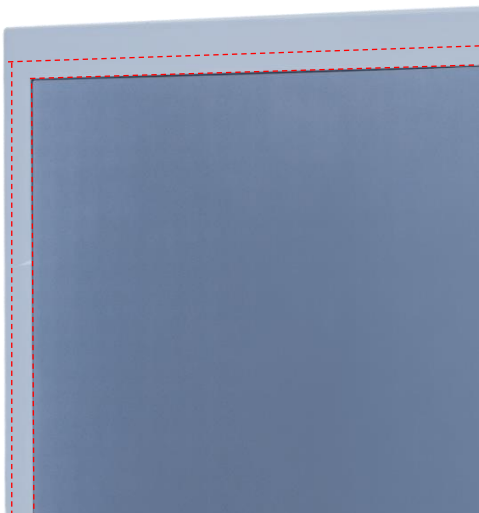

Open-frame Brackets (Option)



Dimension for Installing with Open-frame Brackets

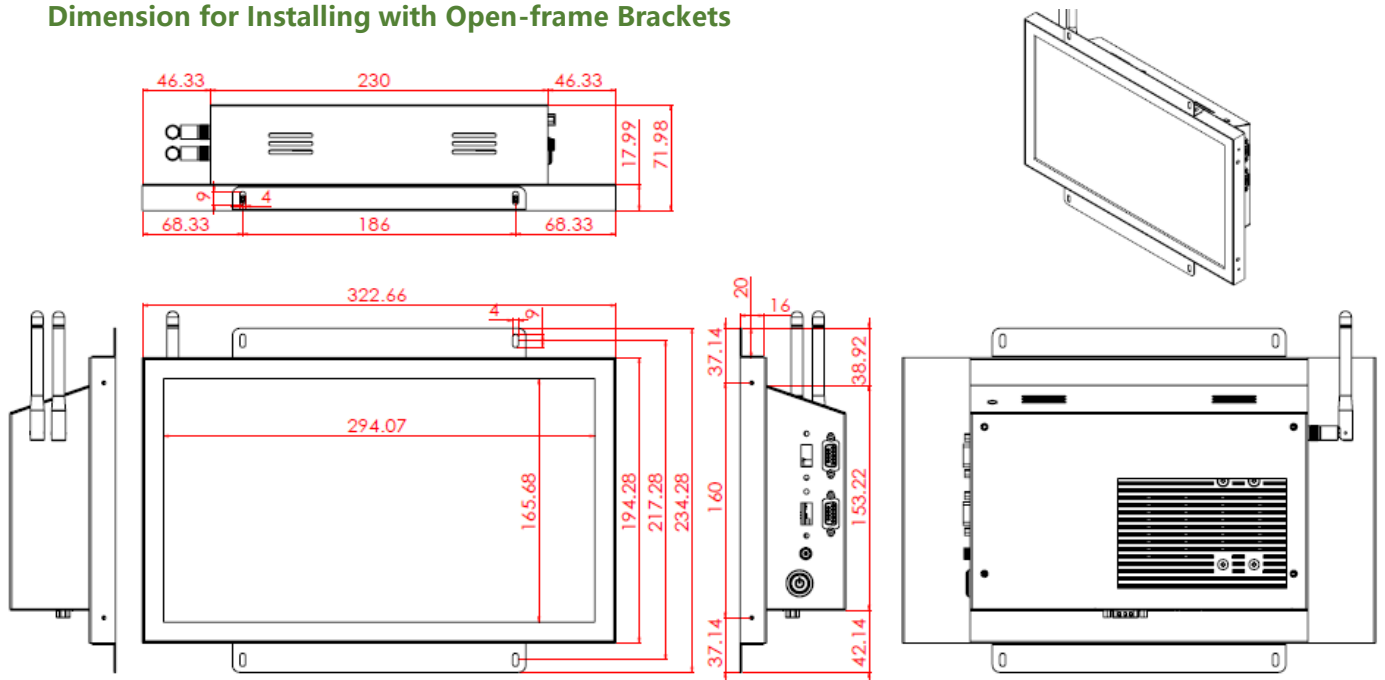

Panel Mount Kits (Option)



Dimension for Installing with Panel Mount Kits

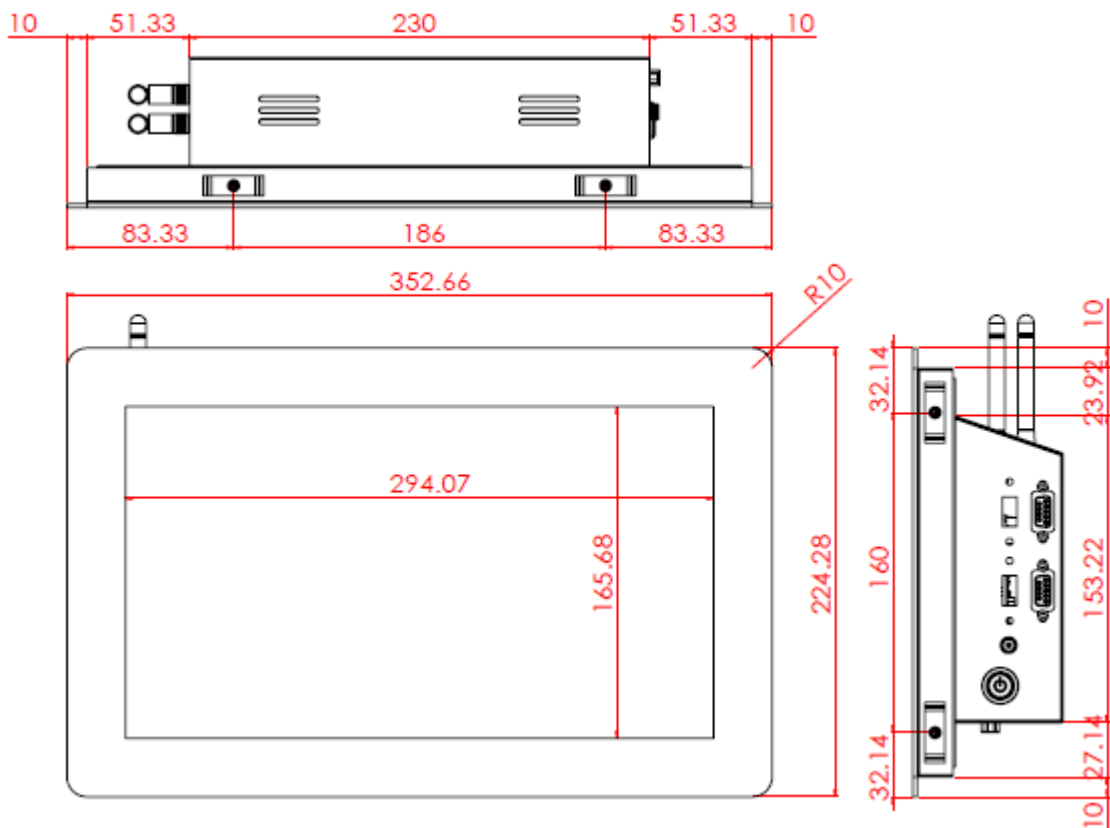

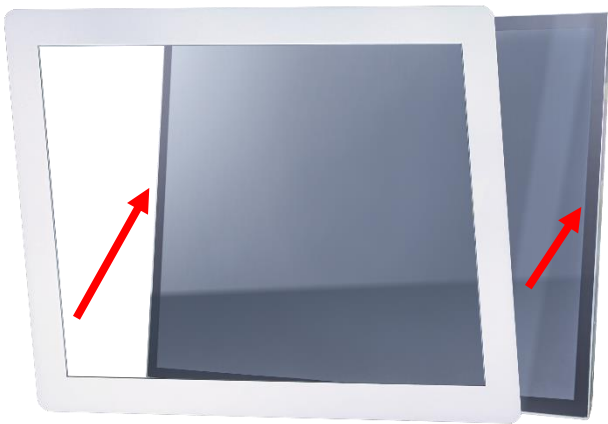

Step 1: Assemble the front module with the screen body. (This step is pre-assembled at the factory.)

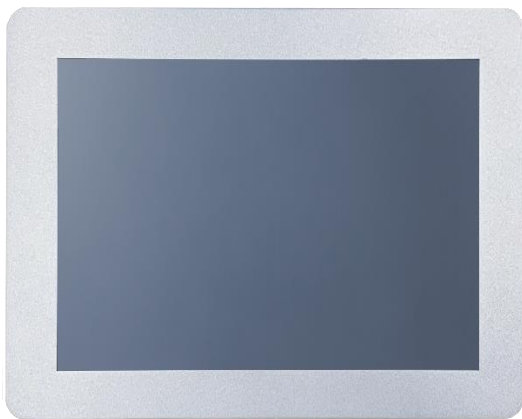
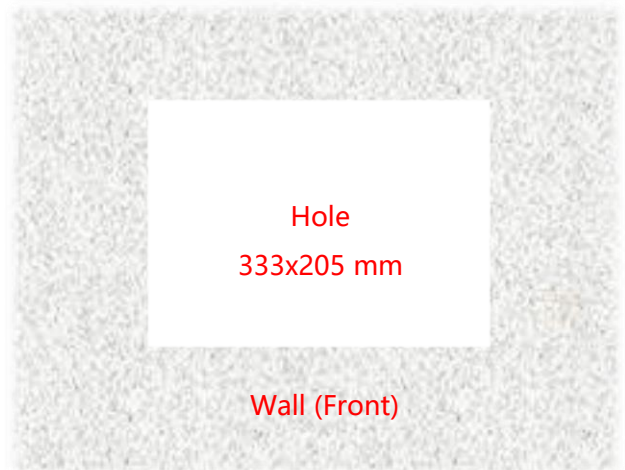

Step 2: Insert the screen from the front into the pre-cut opening.

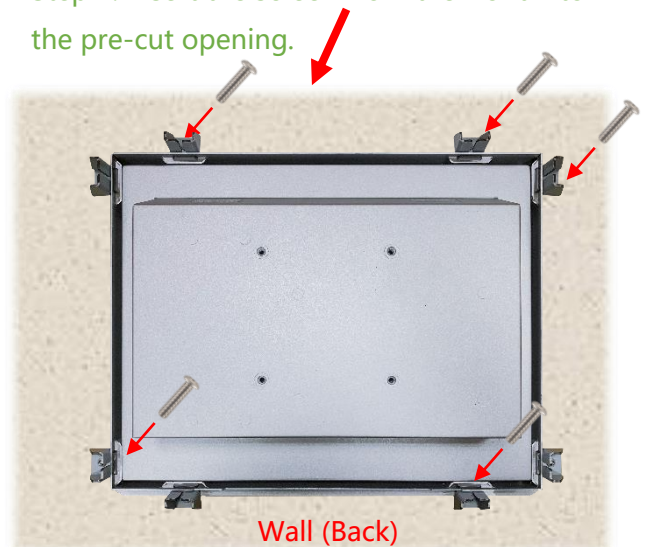

Step 3: Attach the clips from the back and secure with screws. (Up to 10 clips can be installed as needed or per positional limitations.)

Desktop Stand (Option)

Item	L Stand	Part No.	DST-0B004/DST-1B004
Mounting Pattern	100x100 / 75x75 mm	Dimension (WxHxD)	194x194x222 mm
Material	SECC	Net Weight	1.4 KG
Tilt (Hinge)	105°	Support Max. Weight	15 KG

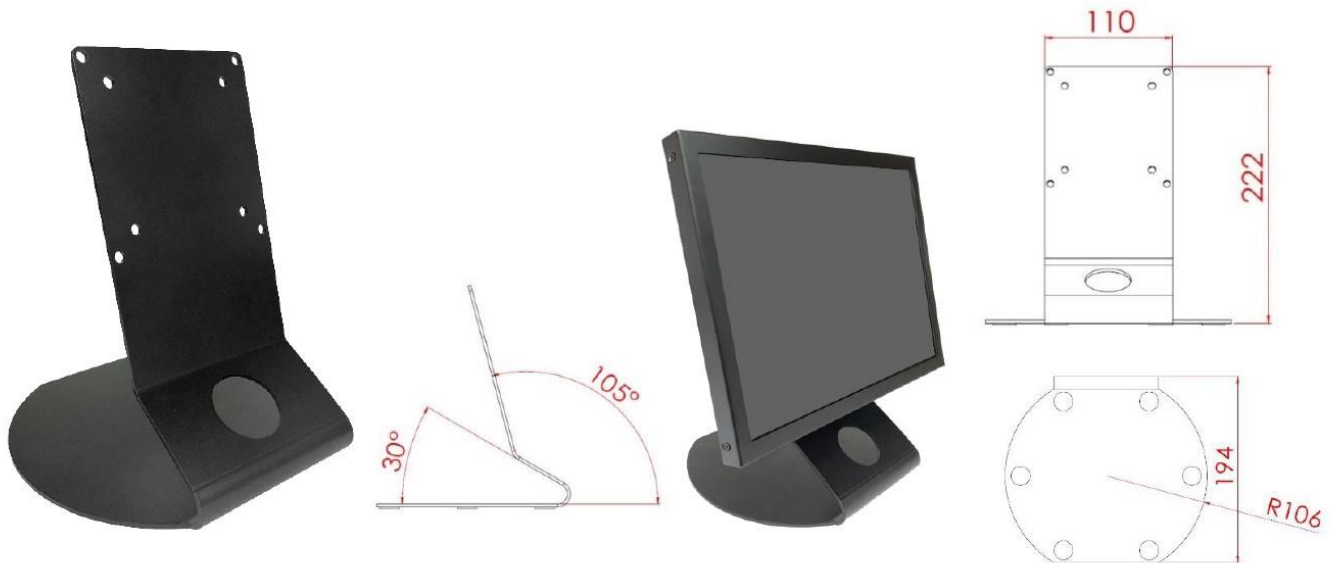

Item	B Stand	Part No.	DST-0B002/DST-1B002
Mounting Pattern	100x100 / 75x75 mm	Dimension (WxHxD)	203x275x227 mm
Material	Steel/Plastic/Aluminum	Net Weight	1.8 KG
Tilt (Hinge)	-2° ~ +180°	Support Max. Weight	15 KG



Wall Mount Bracket (Option)

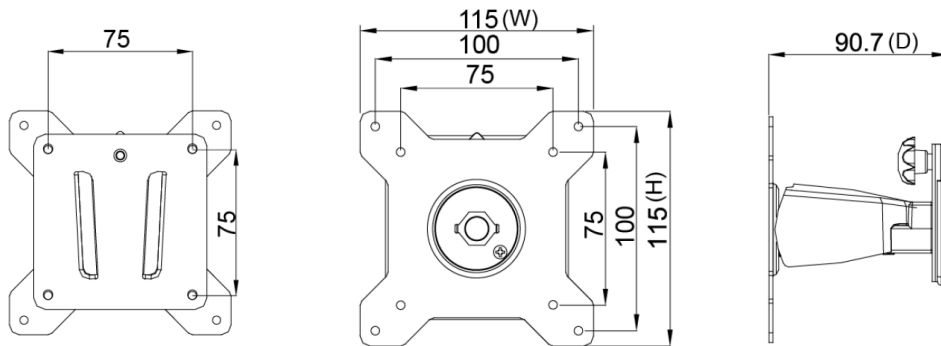
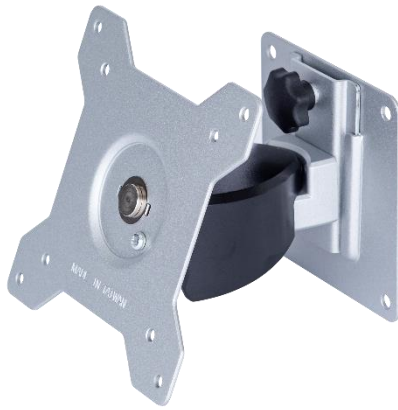

Packing Information

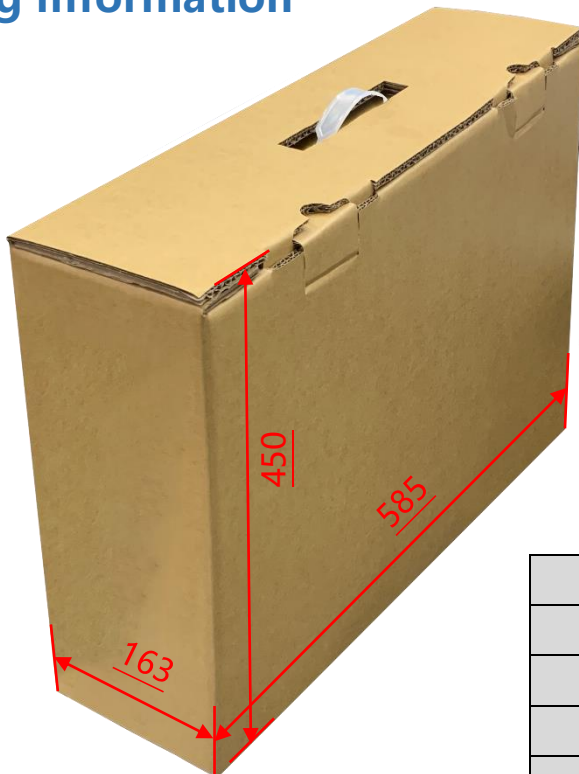

Unit Carton Size	585x163x450 mm
Unit N. Weight	≤2.4 KG
Unit G. Weight	≤3.0 KG
Units per Pallet	36 units
Pallet Size	120x100x147 CM

Physical Specifications

Dimension	323x194x72(±2)mm (W/o Antenna)	Net Weight	≤2.4 KG
-----------	--------------------------------	------------	---------

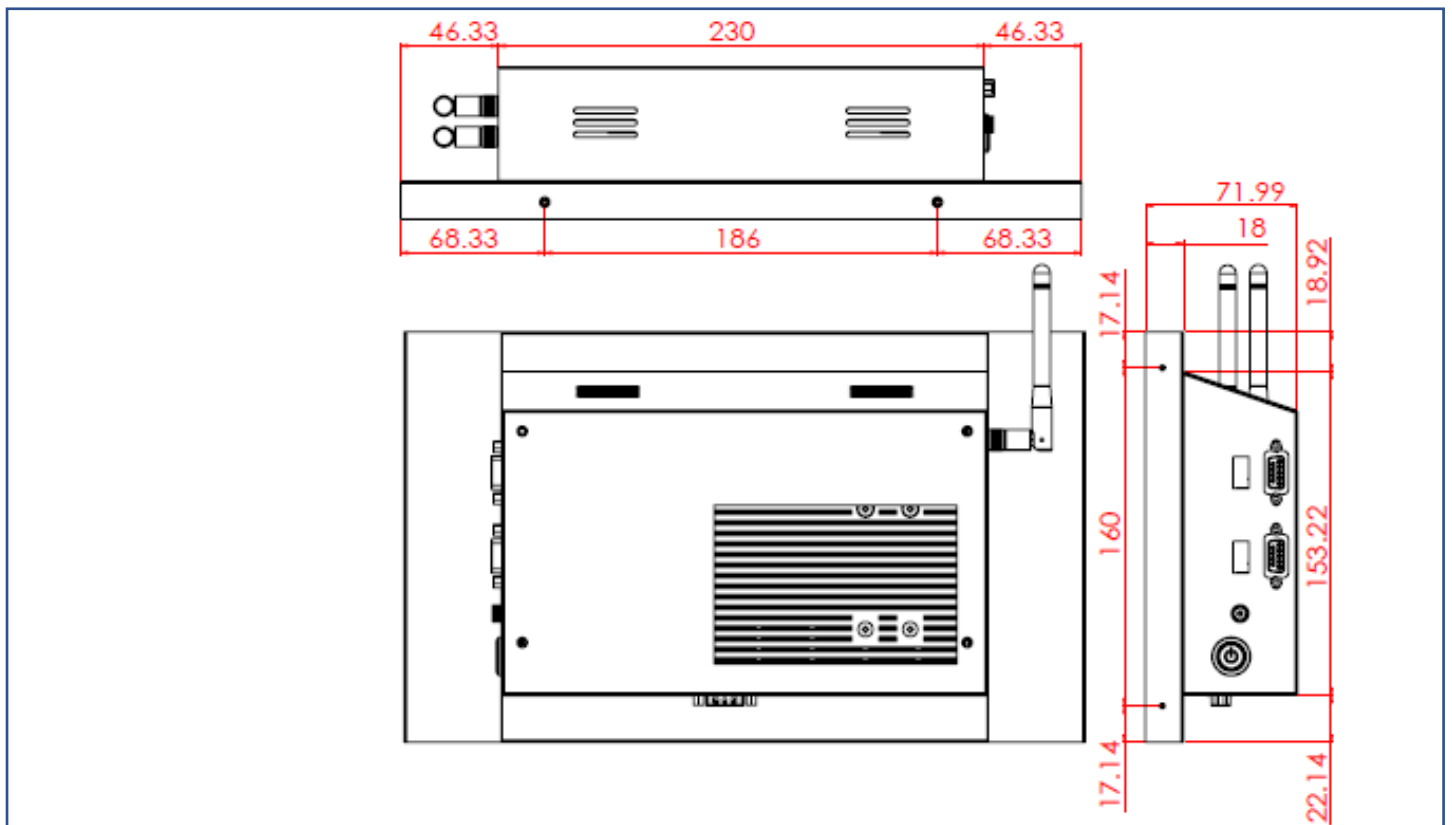
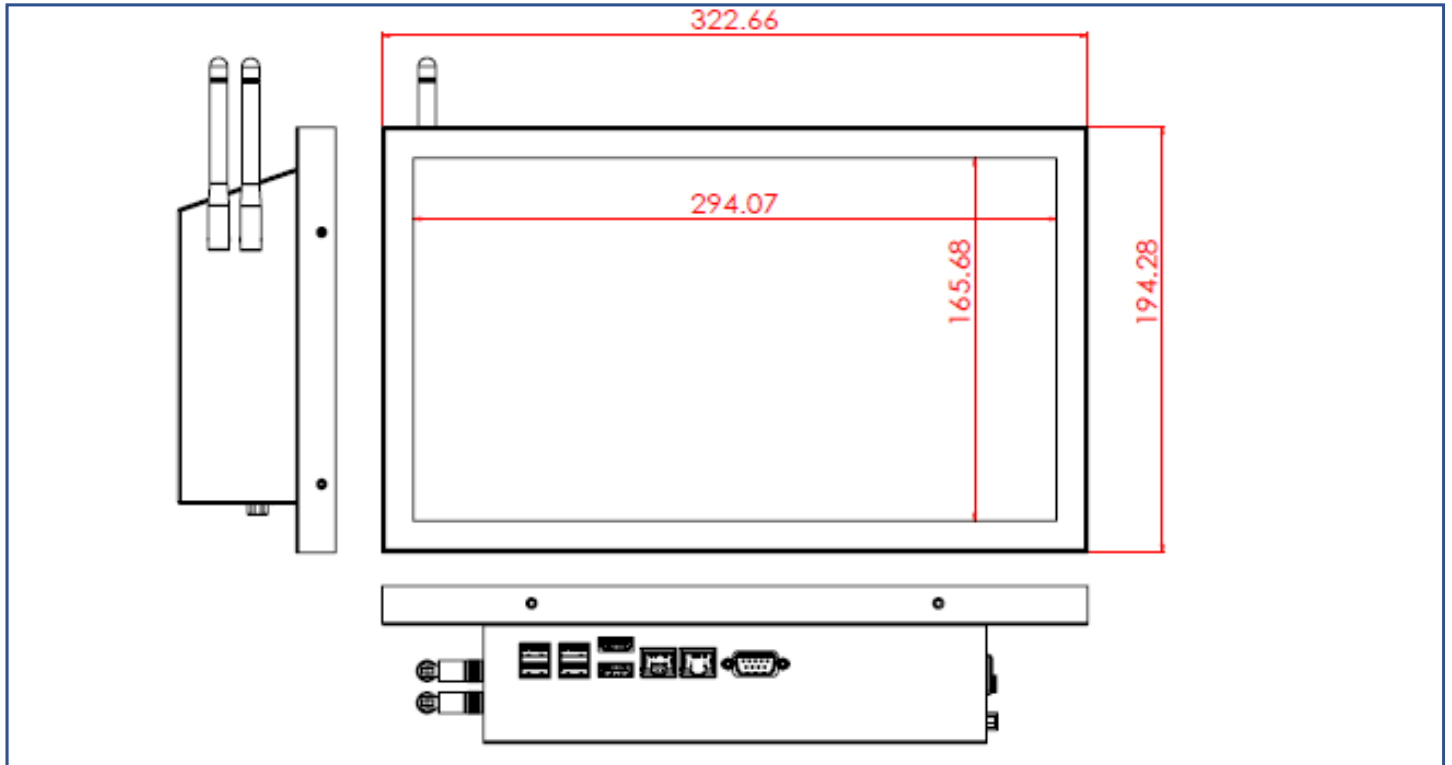

Cosmetic Inspection Standard

Display Area Allowance			
Defect description	Defective Specifications	Allowance	Remarks
Dot Defect (including dark dot, particles, bubbles, pits, dust, foreign matter)	$D \leq 0.2\text{mm}$	Ignored	D=Diameter
	$0.2 < D \leq 0.7\text{mm}$	$N \leq 5$	N=Quantity
	$0.7 < D \leq 1\text{mm}$	$N \leq 3$	
	$D > 1\text{mm}$	$N \leq 0$	
Linear Defect (including scratches, fluff, particles)	$W \leq 0.15\text{mm}$	Ignored	W=Width
	$0.15 < W \leq 0.5\text{mm}, L \leq 15\text{mm}$	$N \leq 2$	L=Length
	$W > 0.5\text{mm}$ or $L > 15\text{mm}$	NG	

* Visual inspection distance: 60cm, 90 degree (same for front/side/back)

Front Appearance Allowance (Including Coating)			
Defect description	Defective Specifications	Allowance	Remarks
Dot Defect (including particles, bubbles, pits...etc.)	$D \leq 0.7\text{mm}$	Ignored	D=Diameter
	$0.7 < D \leq 1.5\text{mm}$	$N \leq 3$	N=Quantity
	$D > 1.5\text{mm}$	$N \leq 0$	
Linear Defect (including scratches, fluff, particles)	$W \leq 0.2\text{mm}, L \leq 15\text{mm}$	Ignored	W=Width, L=Length
	$0.2 < W \leq 0.7\text{mm}, L \leq 15\text{mm}$	$N \leq 1$	
	$W > 0.7\text{mm}$ or $L > 15\text{mm}$	NG	

Side / Back Appearance Allowance (Including Coating)			
Defect description	Defective Specifications	Allowance	Remarks
Dot Defect (including particles, bubbles, pits...etc.)	$D \leq 1.5\text{mm}$	Ignored	D=Diameter
	$1.5 < D \leq 3\text{mm}$	$N \leq 8$	N=Quantity
	$D > 3\text{mm}$	$N \leq 2$	
Linear Defect (including scratches, fluff, particles)	$W \leq 0.8\text{mm}, L \leq 15\text{mm}$	Ignored	W=Width, L=Length
	$0.8 < W \leq 1.5\text{mm}, L \leq 15\text{mm}$	$N \leq 5$	
	$W > 1.5\text{mm}$ or $L > 15\text{mm}$	NG	



Display Area
(Red Area)



Front Appearance (Red Area)



Back Appearance