



Product Specifications

Customer	
Model	NTSM070 V500



Records of Revision			
Vision	Modifying	Old Description	New Description
v2110.2	Preliminary Specifications		

Features

- ★ 7 inch Industrial Grade Panel, 800x480 Resolution
- ★ Wide Operating Temperature Range -30~85°C
- ★ Projected Capacitive Touch Screen
- ★ 7H Hardness Tempered Cover Glass
- ★ 10 points Multi-touch
- ★ Metal Cabinet with Diverse Combine Options
- ★ Made in Taiwan, 3 Years Warranty, Designed for Harsh Environments
- ★ Optional High Brightness 1500nits, for Outdoor Environment
- ★ Optional AG Coating/Antibacterial/Privacy Filter Surface Treatment



PSE



BSMI



RoHS



CE



ISO9001



FCC



Open-frame Brackets



Panel Mount



Display Specifications

Model Name	NTSM070 <u>XX</u> S32- <u>XXXXX</u> 0-500*	Display Mode	TN Mode, Normally White
Screen Diagonal	117.8 mm (7.0 inch)	Backlight Unit	LED (white LED)
Display Area	152.4x91.44 mm	Viewing Angle (L/R, U/D)	160°/160° (CR=10)
Resolution	800x480	Backlight Lifetime	>50,000 Hours
Contrast Ratio	1000:1	Operating Temp.	-30~85°C
Support Colors	16.2M Colors	Storage Temp.	-30~85°C
Pixel Pitch	0.1905x0.1905 mm	Surface Treatment	Anti-glare, Hardness 3H
Response Time	8 msec.		

* X = A~Z, 0~9 (Depends on options)

Display Options

Brightness			
	Brightness	Environment	Model Name
Standard	400nits	General (Indoor)	NTSM070 <u>N</u> XS32- <u>XXXXX</u> 0-500
Option 1	1000nits	Outdoor Environment	NTSM070 <u>A</u> XS32- <u>XXXXX</u> 0-500
Option 2	1500nits	Sunlight Readable	NTSM070 <u>F</u> XS32- <u>XXXXX</u> 0-500

Accessories

Item	Description	Quantity
HDMI Cable	Male to Male, 1.8 Meter	1
AC-DC Adapter	12V with CE/FCC/CCC/UL/RoHS/PSE/JET Certification	1
Power Cord	*Country Specific	1
USB Cable	A type, Male to Male, 1.8 Meter *(only for touch monitor)	1



Touch Options

Projected Capacitive Touch			
Model Name	NTSM070X <u>P</u> S32- <u>XXXXU</u> 0-500		
Touch Technology	Projected Capacitive	Transparency	≥87%
Allowed Touch Points	10 points	Accuracy	99.00%
Interface	USB	Thickness of Cover Lens	2.0±0.2mm
IK Ratings	IK07	Hardness of Cover Lens	7H

Non-Touch	
Model Name	NTSM070X <u>0</u> S32- <u>XXXX0</u> 0-500

Surface Film		
	Description	Model Name
Standard	(none)	NTSM070X<u>X</u>S32-<u>00XXX</u>0-500
Option 1	Anti-Glare Coating	NTSM070X <u>X</u> S32- <u>GGXXX</u> 0-500
Option 2	Antibacterial (AB Film)	NTSM070X <u>X</u> S32- <u>ABXXX</u> 0-500
Option 3	Anti-Spy (AS Film)	NTSM070X <u>X</u> S32- <u>SFXXX</u> 0-500



General Options

Color of Cabinet		
	Description	Model Name
Standard	Black	NTSM070XXS32-XXBXX0-500
Option 1	White	NTSM070XXS32-XXWXX0-500
Option 2	Silver	NTSM070XXS32-XXSXX0-500
Options	Other Colors	NTSM070XXS32-XXXXX0-500

* X = A~Z, 0~9 (Depends on Color)

Material of Cabinet		
	Description	Model Name
Standard	SECC	NTSM070XXS32-XXXSX0-500
Option 1	Stainless Steel	NTSM070XXS32-XXXLX0-500
Option 2	Aluminum	NTSM070XXS32-XXXAX0-500

Touch Interface		
	Description	Model Name
Option 1	USB	NTSM070XPS32-XXXXU0-500
Option 2	Non-Touch	NTSM070X0S32-XXXX00-500

Supported OS

Windows	Win7, Win8, Win10, Win11 ↑
Linux	Kernel 2.6.24 ↑
Android	3.0 ↑
Mac	10.5.x ↑ (Intel CPU)

Input /Output System

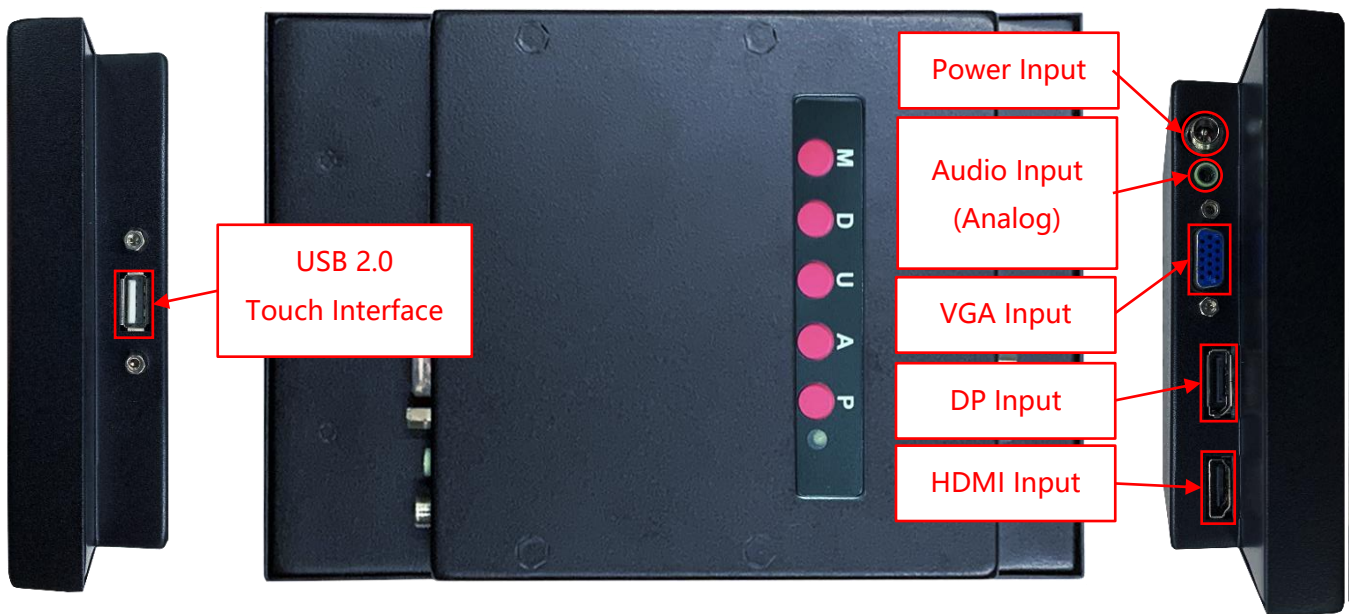

Packing Information



Dimensions of Carton	390x320x90 mm
Net Weight	≤0.9 KG
Gross Weight	≤1.9 KG

Open-frame Brackets (Option)

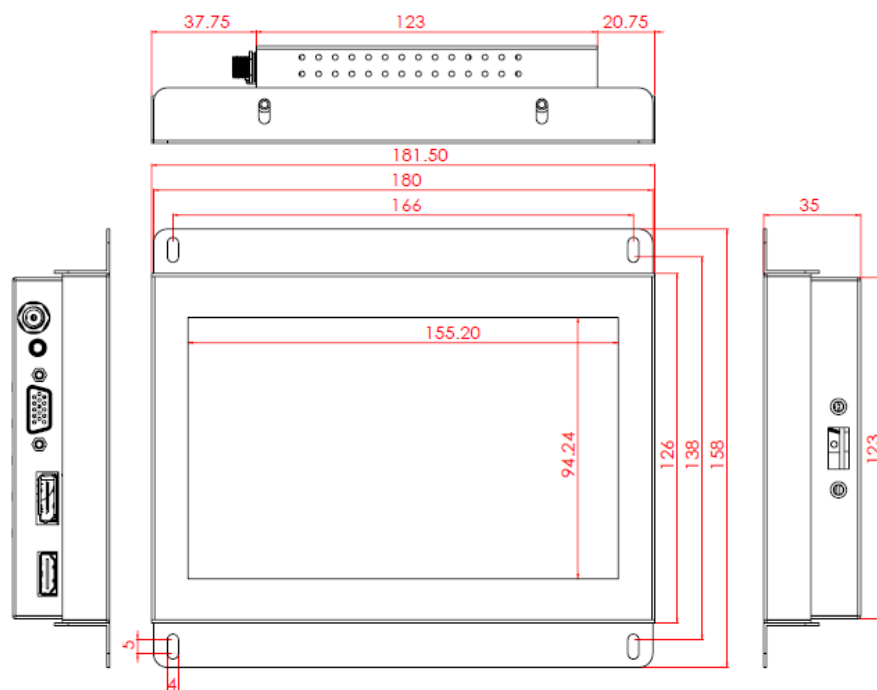
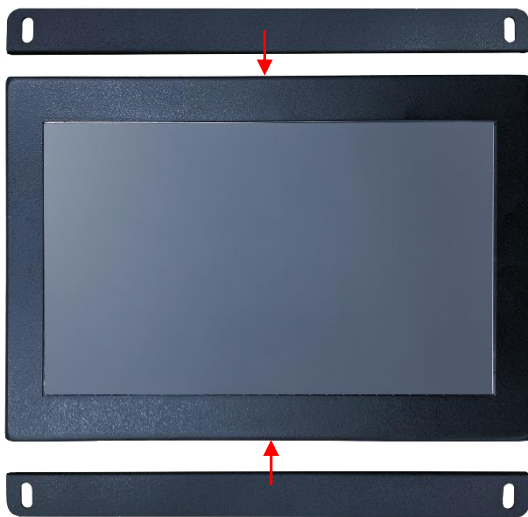

Panel Mount Kits (Option)

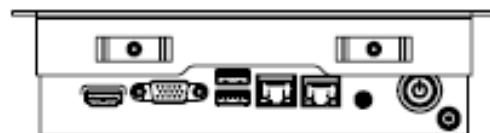
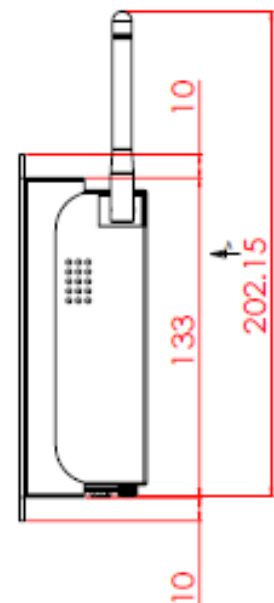
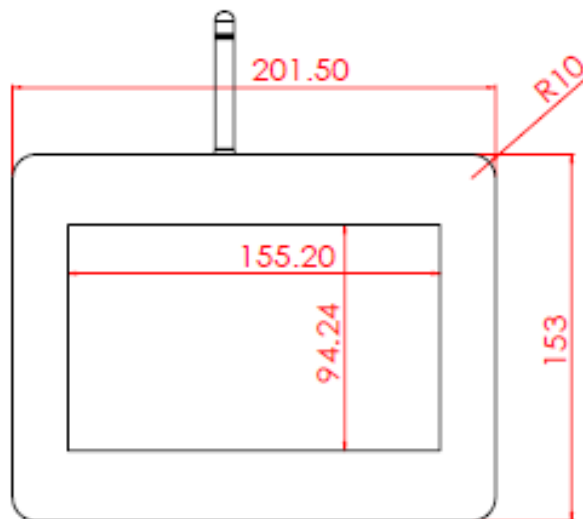
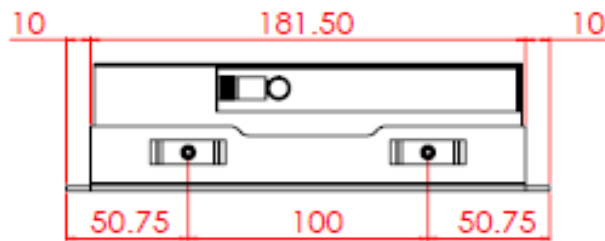

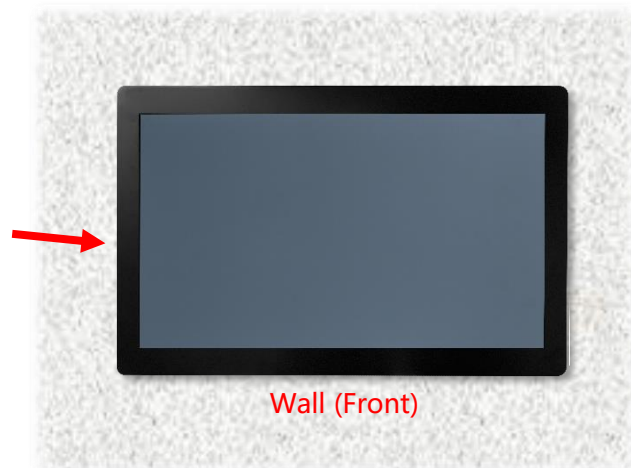
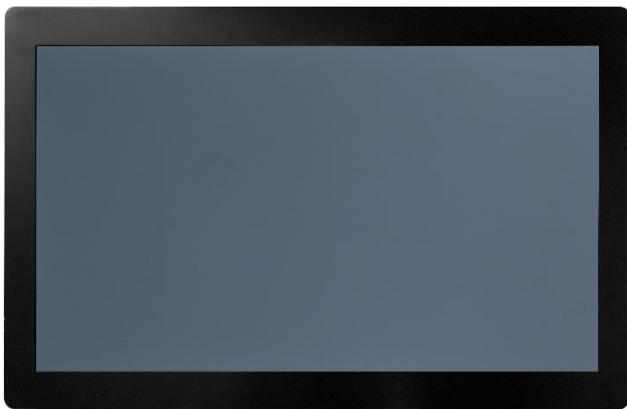
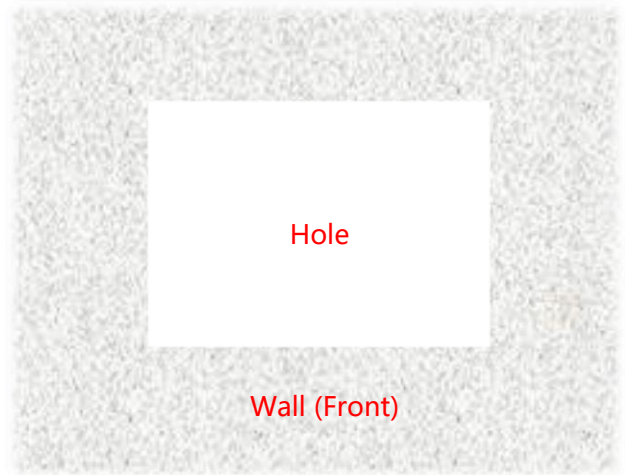

Physical Specifications

Dimension (Max)	181.5x126x35(±2)mm	Net Weight	≤0.9 KG
-----------------	---------------------------	------------	----------------

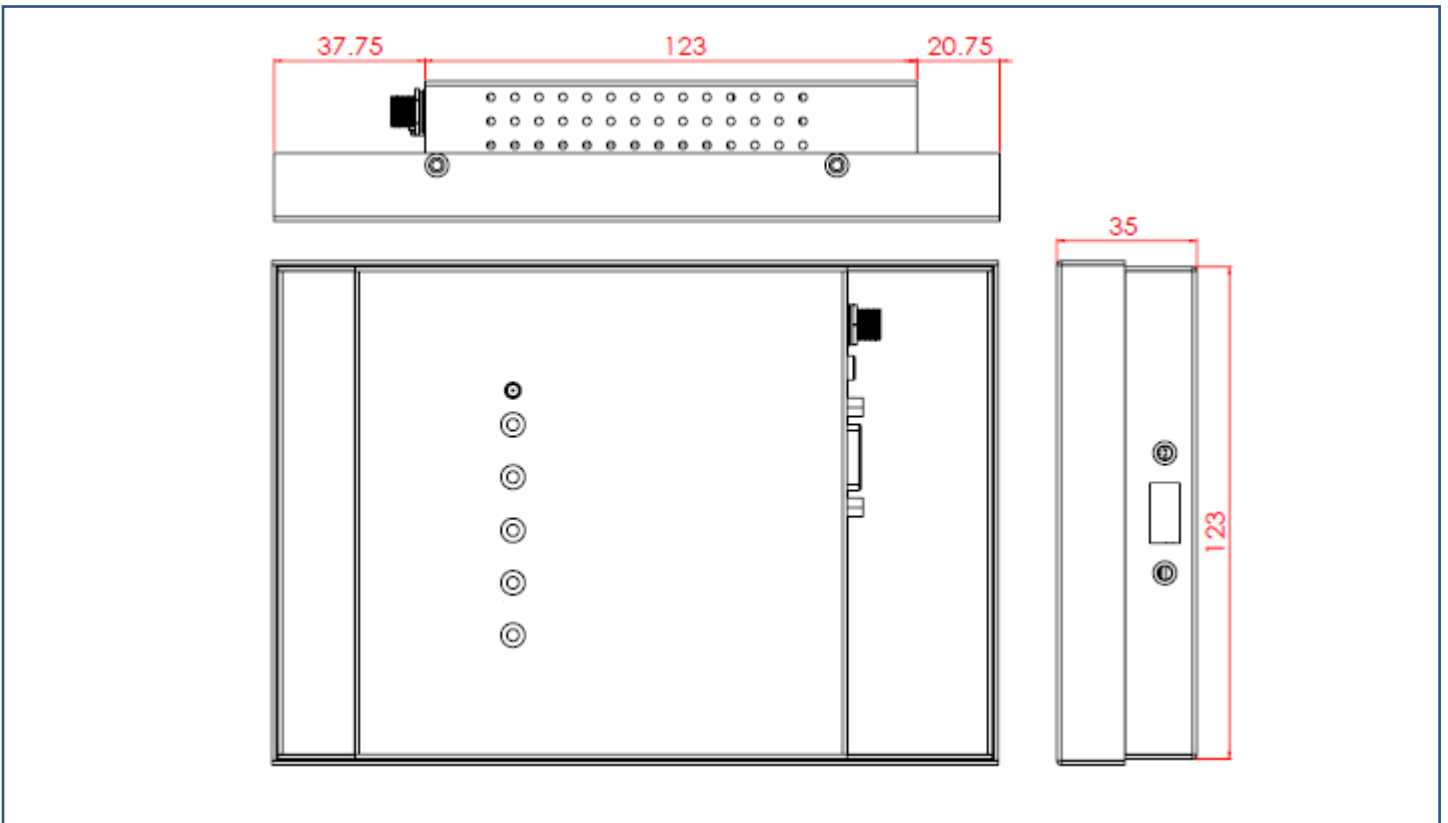
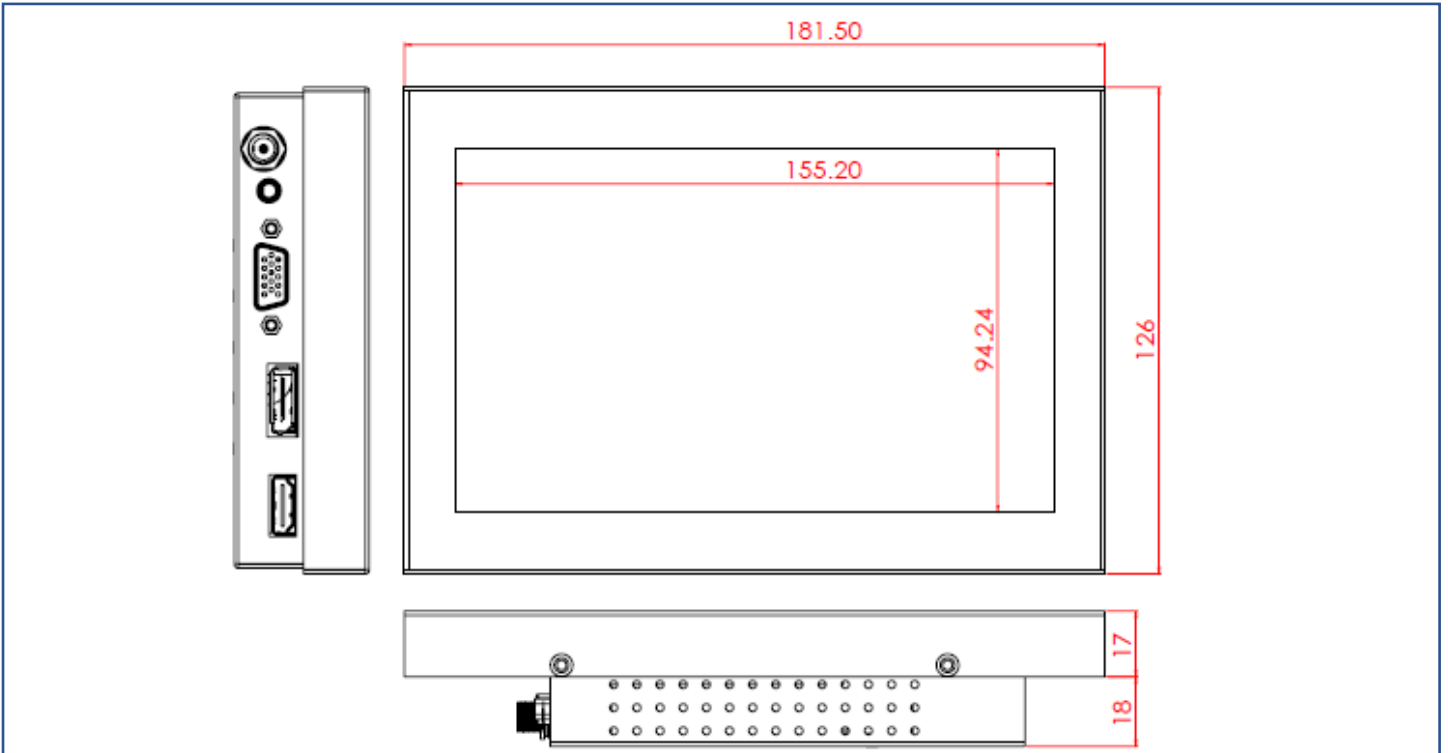

Cosmetic Inspection Standard

Display Area Allowance			
Defect description	Defective Specifications	Allowance	Remarks
Dot Defect (including dark dot, particles, bubbles, pits, dust, foreign matter)	$D \leq 0.2\text{mm}$	Ignored	D=Diameter
	$0.2 < D \leq 0.7\text{mm}$	$N \leq 5$	N=Quantity
	$0.7 < D \leq 1\text{mm}$	$N \leq 3$	
	$D > 1\text{mm}$	$N \leq 0$	
Linear Defect (including scratches, fluff, particles)	$W \leq 0.15\text{mm}$	Ignored	W=Width
	$0.15 < W \leq 0.5\text{mm}, L \leq 15\text{mm}$	$N \leq 2$	L=Length
	$W > 0.5\text{mm}$ or $L > 15\text{mm}$	NG	

* Visual inspection distance: 60cm, 90 degree (same for front/side/back)

Front Appearance Allowance (Including Coating)			
Defect description	Defective Specifications	Allowance	Remarks
Dot Defect (including particles, bubbles, pits...etc.)	$D \leq 0.7\text{mm}$	Ignored	D=Diameter
	$0.7 < D \leq 1.5\text{mm}$	$N \leq 3$	N=Quantity
	$D > 1.5\text{mm}$	$N \leq 0$	
Linear Defect (including scratches, fluff, particles)	$W \leq 0.2\text{mm}, L \leq 15\text{mm}$	Ignored	W=Width, L=Length
	$0.2 < W \leq 0.7\text{mm}, L \leq 15\text{mm}$	$N \leq 1$	
	$W > 0.7\text{mm}$ or $L > 15\text{mm}$	NG	

Side / Back Appearance Allowance (Including Coating)			
Defect description	Defective Specifications	Allowance	Remarks
Dot Defect (including particles, bubbles, pits...etc.)	$D \leq 1.5\text{mm}$	Ignored	D=Diameter
	$1.5 < D \leq 3\text{mm}$	$N \leq 8$	N=Quantity
	$D > 3\text{mm}$	$N \leq 2$	
Linear Defect (including scratches, fluff, particles)	$W \leq 0.8\text{mm}, L \leq 15\text{mm}$	Ignored	W=Width, L=Length
	$0.8 < W \leq 1.5\text{mm}, L \leq 15\text{mm}$	$N \leq 5$	
	$W > 1.5\text{mm}$ or $L > 15\text{mm}$	NG	

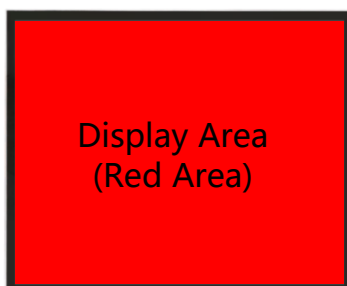

Display Area
(Red Area)



Front Appearance (Red Area)



Back Appearance