

Product Specifications

Customer	
Model	NTSI430-2 V500



Records of Revision			
Vision	Modifying	Old Description	New Description
v2209.1	Preliminary Specifications		
v2209.2	New trademark released		

Features

- ★ 43 inch Industrial Grade Panel, 1920x1080 (FHD) Resolution
- ★ VA Wide Viewing Angel 178°/178°
- ★ 1500nits High Brightness
- ★ Optional I.R. Touch
- ★ 10 points Multi-touch, 7H Hardness Tempered Cover Glass
- ★ Metal Cabinet with Diverse Combine Options
- ★ Made in Taiwan, 3 Years Warranty, Designed for Harsh Environments
- ★ Optional Software Remote Control by RS232
- ★ Optional Auto Dimming Function (with Light Sensor)



PSE



BSMI



RoHS



CE



ISO9001



FCC



Wall Mounting



Cart



KIOSK Cabinet

Display Specifications

Model Name	NTSI430HX2DA-XXXXXF-500*	Display Mode	VA, Normally Black
Screen Diagonal	43 inch.	Response Time	8 msec.
Display Area	940.9x529.25 mm	Backlight Unit	LED (white LED)
Resolution	1920x1080 (FHD)	Viewing Angle (L/R, U/D)	178°/178° (CR=10)
Contrast Ratio	4000:1	Backlight Lifetime	>70,000 Hours
Display Ratio	16:9	Operating Temp.	0~50°C
Support Colors	16.7M Colors	Storage Temp.	-20~60°C
Pixel Pitch	0.49x0.49 mm	Brightness	1500 nits

* X = A~Z, 0~9 (Depends on options)

Touch Options

I.R. Touch			
Model Name	NTSI430HI2DA-XXXXUF-500		
Touch Technology	I.R. Touch	Transparency	≥92%
Allowed Touch Points	10 points	Accuracy	99.00%
Interface	USB	Thickness of Cover Lens	4.0±0.2mm
IK Ratings	IK07	Hardness of Cover Lens	7H

Non-Touch	
Model Name	NTSI430H02DA-XXXX0F-500

Surface Treatment		
	Description	Model Name
Standard	(none)	NTSI430HX2DA-00XXXXF-500
Option	Anti-Glare Coating	NTSI430HX2DA-GGXXXXF-500

General Options

Color of Cabinet		
	Description	Model Name
Standard	Black	NTSI430HX2DA-XXBXXF-500
Option 1	White	NTSI430HX2DA-XXWXXF-500
Option 2	Silver	NTSI430HX2DA-XXSXXF-500
Options	Other Colors	NTSI430HX2DA-XXXXF-500

* X = A~Z, 0~9 (Depends on Color)

Material of Cabinet		
	Description	Model Name
Standard	SECC	NTSI430HX2DA-XXXSXF-500
Option 1	Stainless Steel	NTSI430HX2DA-XXXLXF-500
Option 2	Aluminum	NTSI430HX2DA-XXXAXF-500

Touch Interface		
	Description	Model Name
Standard	USB	NTSI430HX2DA-XXXXUF-500
Option	Non-Touch	NTSI430HX2DA-XXXXOF-500

Accessories

Item	Description	Quantity
HDMI Cable	HDMI Male to Male, 1.8 Meter	1
Power Cord	*Country Specific	1
USB Cable	A type, Male to Male, 1.8 Meter*	1

Input /Output

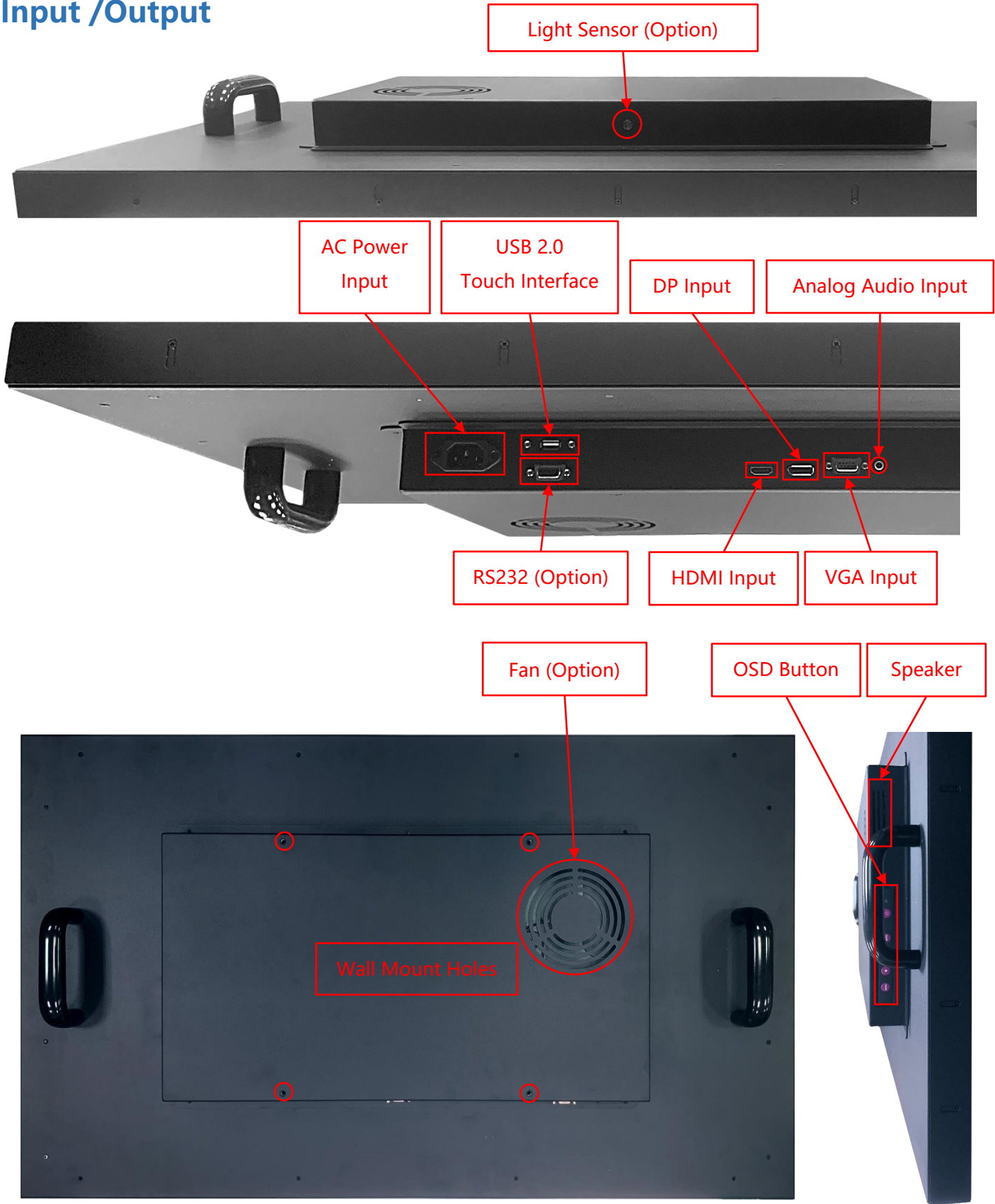

Other Options

OSD Control		
	Item	Description
Standard	Button	Rear Physical Button
Option 1	Software Remote Control	Software Remote Control by RS232/Serial Port
Option 2	Auto Dimming	Auto Brightness Adjusting by Light Sensor

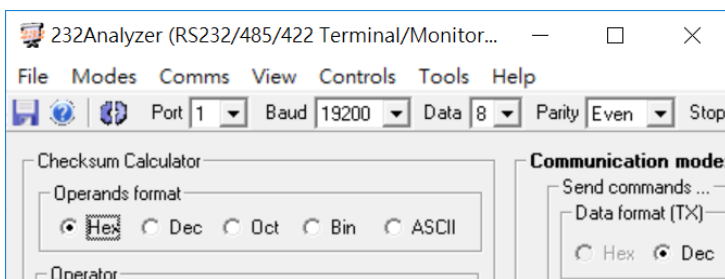

* Software Remote

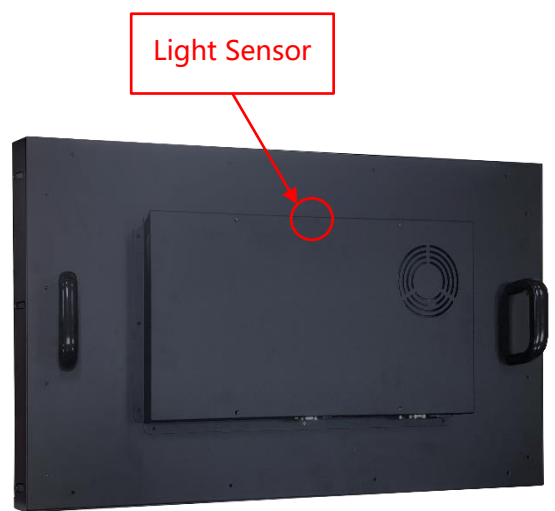

Packing Information



Dimensions of Carton	116x28x80 CM
Net Weight	≤23 KG
Gross Weight	≤31 KG

Wall Mount Bracket (Option)

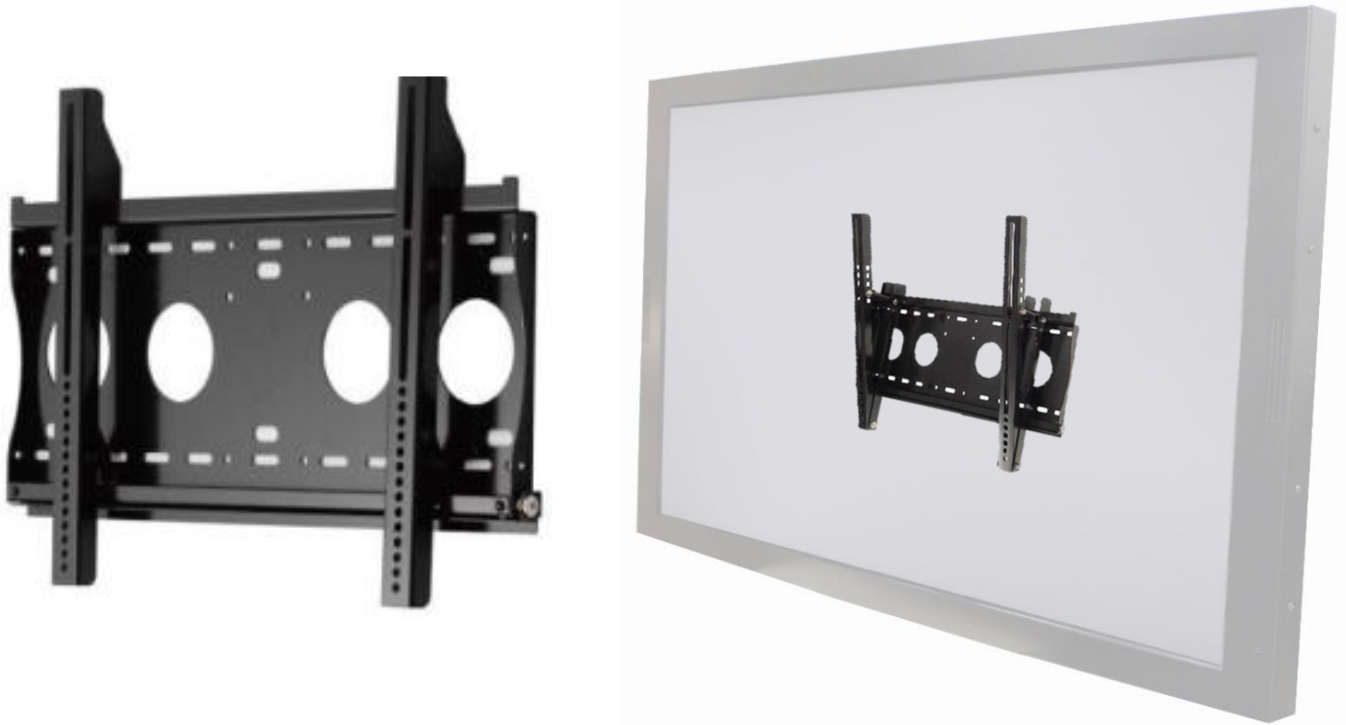

Part No.	WMB-B001		
Mounting Pattern	Max. 400x450 mm	Dimension (WxHxD)	508x490x48 mm
Material	SECC	Net Weight	4.01 KG
Tilt (Hinge)	0°/5°/10°/13°/15°	Support Max. Weight	80 KG
Screw Type	M4/M5/M6/M8	Min. Distance to The Wall	48 mm

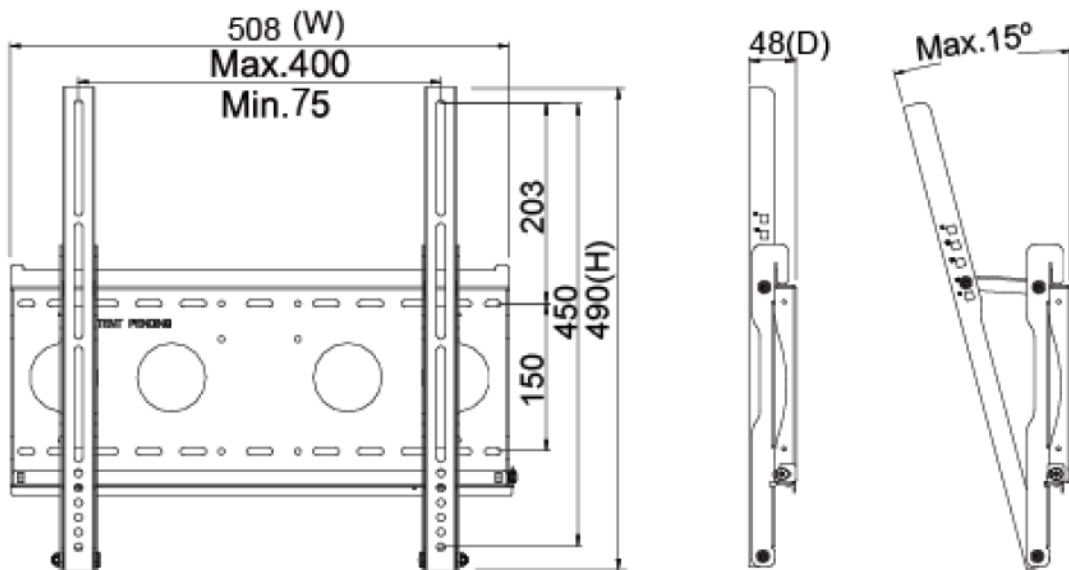

Nextech I Series 43" Industrial Display/Touch Display

NTSI430-2 V500

Cart (Option)



Net Weight	28.4 KG
Power System	AC 200~240V 50/60Hz
User Interface	Button (up/down)
Packaged Dimension	W1160xD833xH1727 mm
Screw Type	M4/M5/M6/M8
Material	Aluminum/Plastic/Steel
Max. Mount Pattern	800x600mm
Max. Weight Load	80 KG
Caster	4 (front 2 braking)
Height Adjust Range	455 mm
RoHS/REACH	Yes

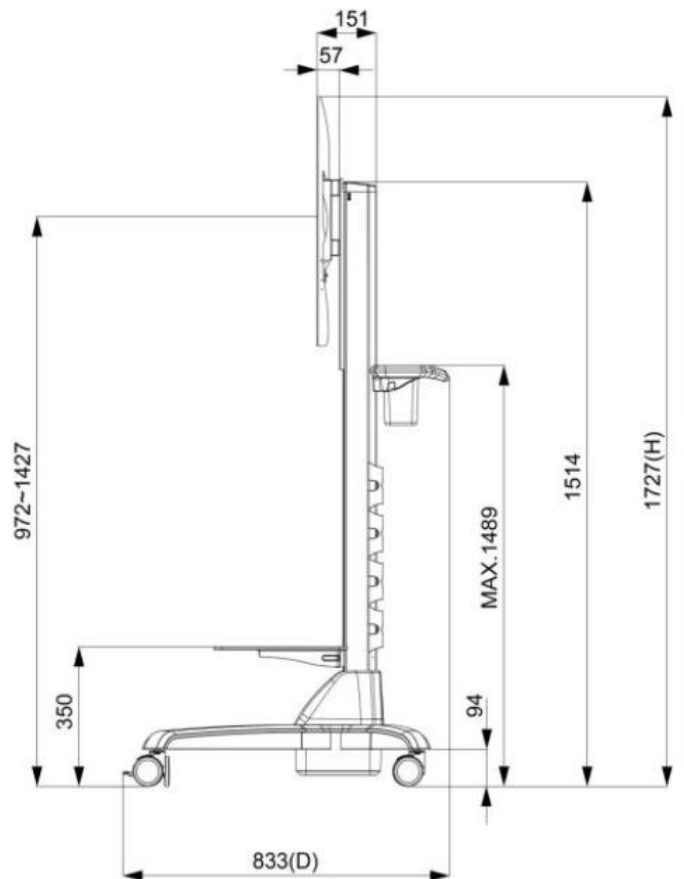
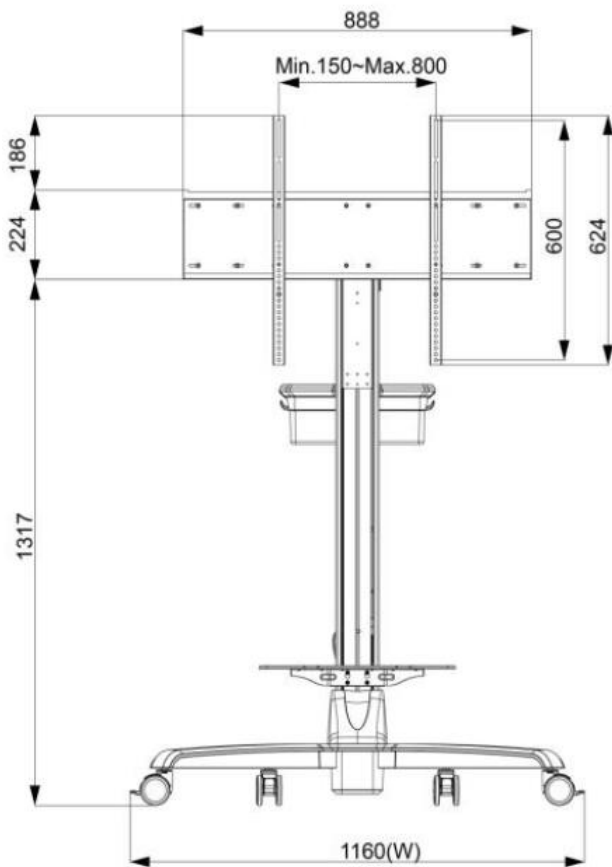

KIOSK Cabinet (Option)



Material	SECC
Caster	4 (front 2 braking)
Ingress Protection	Front IP65
Power Socket	None (Wire Hole Reserved)



Physical Specifications

Dimension (Max)	997x585x102.5(±2)mm	Net Weight	≤23 KG
VESA Mounting	300x300 mm	Gross Weight	≤31 KG

