



Product Specifications

Customer	
Model	NTI320 V021



Records of Revision			
Vision	Modifying	Old Description	New Description
v1909.1	Preliminary Specifications		
v1909.2	Revise Dimensions		

Features

- ★ 32" 16:9 ,1920x1080 (Full-HD) Resolution
- ★ 2500nits High Brightness
- ★ VA Wide Viewing Angel 178°/178°
- ★ I.R. Touch Option, 7H Hardness Tempered Cover Glass
- ★ 10 points Multi-touch
- ★ Metal Cabinet with Diverse Combine Options
- ★ Made in Taiwan, 3 Years Warranty, Designed for Harsh Environments
- ★ Media Play by USB Drive. (PC free!)



PSE



BSMI



FCC



CE



RoHS



ISO9001



Display Specifications

Model Name	NTI320X0XXHXA-031 *	Display Mode	VA, Normally Black
Screen Diagonal	31.5 inch	Response Time	8 msec.
Display Area	698.4x392.9 mm	Backlight Unit	LED (white LED)
Resolution	1920x1080 (FHD)	Viewing Angle (L/R, U/D)	178°/178° (CR≥10)
Contrast Ratio	4000:1	Backlight Lifetime	>70,000 Hours
Display Ratio	16:9	Operating Temp.	0~50°C
Support Color	16.7M Colors	Storage Temp.	-20~60°C
Pixel Pitch	0.3637x0.3637 mm	Surface Treatment	AG Haze 28%, Hardness 3H
Brightness	2500 nits		

* X = A~Z, 0~9 (Depends on options)

Touch Options

I.R. Touch			
Model Name	NTI320I0XUHXA-031		
Touch Technology	I.R. Touch	Transparency	≥92%
Allowed Touch Points	10 points	Accuracy	99.00%
Interface	USB	Thickness of Cover Lens	4.0±0.2mm
IK Ratings	IK07	Hardness of Cover Lens	7H

Non-Touch	
Model No.	NTI320O0X0HXA-021

Supported OS

Windows	Win7, Win8, Win10 ↑
Linux	Kernel 2.6.24 ↑
Android	3.0 ↑
Mac	10.5.x ↑ (Intel CPU)



General Options

Color of Cabinet		
	Description	Model Name
Standard	Black	NTI320X0<u>B</u>XHXA-021
Option 1	White	NTI320X0 <u>W</u> XHXA-021
Option 2	Silver	NTI320X0 <u>S</u> XHXA-021
Options	Other Colors	NTI320X0 <u>X</u> XHXA-021

* X = A~Z, 0~9 (Depends on Color)

Touch Interface		
	Description	Model Name
Standard	USB	NTI320I0X<u>U</u>HXA-021
Option	Non-Touch	NTI320X0X <u>0</u> HXA-021

Material of Cabinet		
	Description	Model Name
Standard	SECC	NTI320X0XXH<u>S</u>A-021
Option 1	Stainless Steel	NTI320X0XXH <u>L</u> A-021
Option 2	Aluminum	NTI320X0XXH <u>A</u> A-021

Accessories

Item	Description	Quantity
HDMI Cable	HDMI Male to Male, 1.5 Meter	1
Power cord	*Country Specific	1
USB Cable	A type, Male to Male, 1.5 Meter *(only for touch monitor)	1

Display Input

Connectors	Description	Connectors	Description
VGA	15pin D-Sub x1	DVI	DVI-I x1
HDMI	HDMI 1.4 x2	USB	USB Type A x1 *

* For media playing function by using USB drives, plays the media files automatically.

Supported Media Format	
Movie	avi, mpg, dat, vob, mov, mkv, rm, rmvb, mp4, mjpeg, ts, trp, wmv, asf, flv
Picture	Jpg, bmp, png
Music	mp3, m4a

Notes

1. Media playing function by using USB driver isn't supporting touch function.
2. Touch function requires a PC, Android or Linux device.
3. Media playing function requires an USB Drive only. (without PC)

Audio System

	Description	Connector
Audio Input	Stereo	TRS Connector Φ 3.5mm (Earphone Jack)
Speakers	10W x2	



Input /Output System

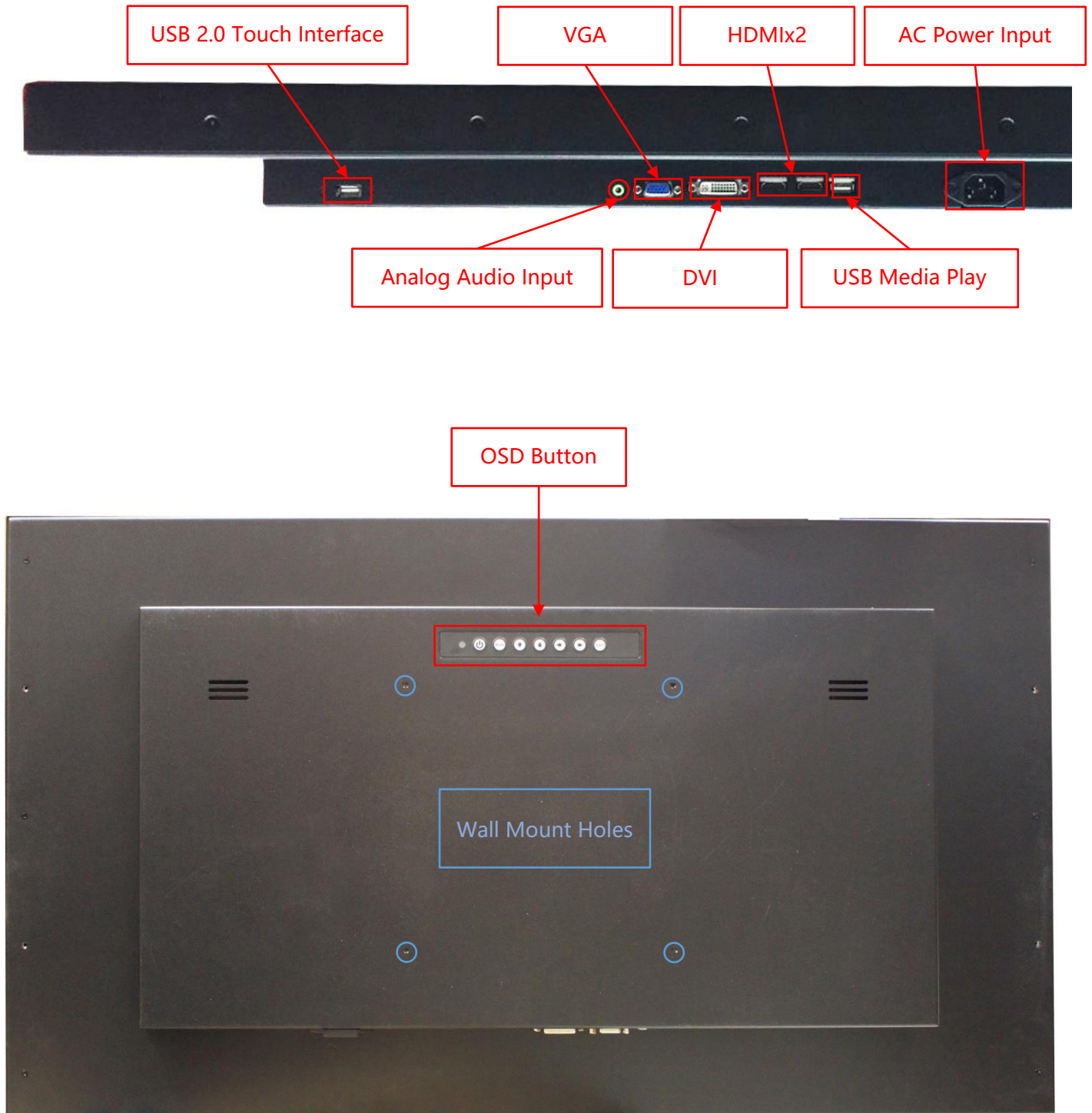

Open-frame Brackets (Option)

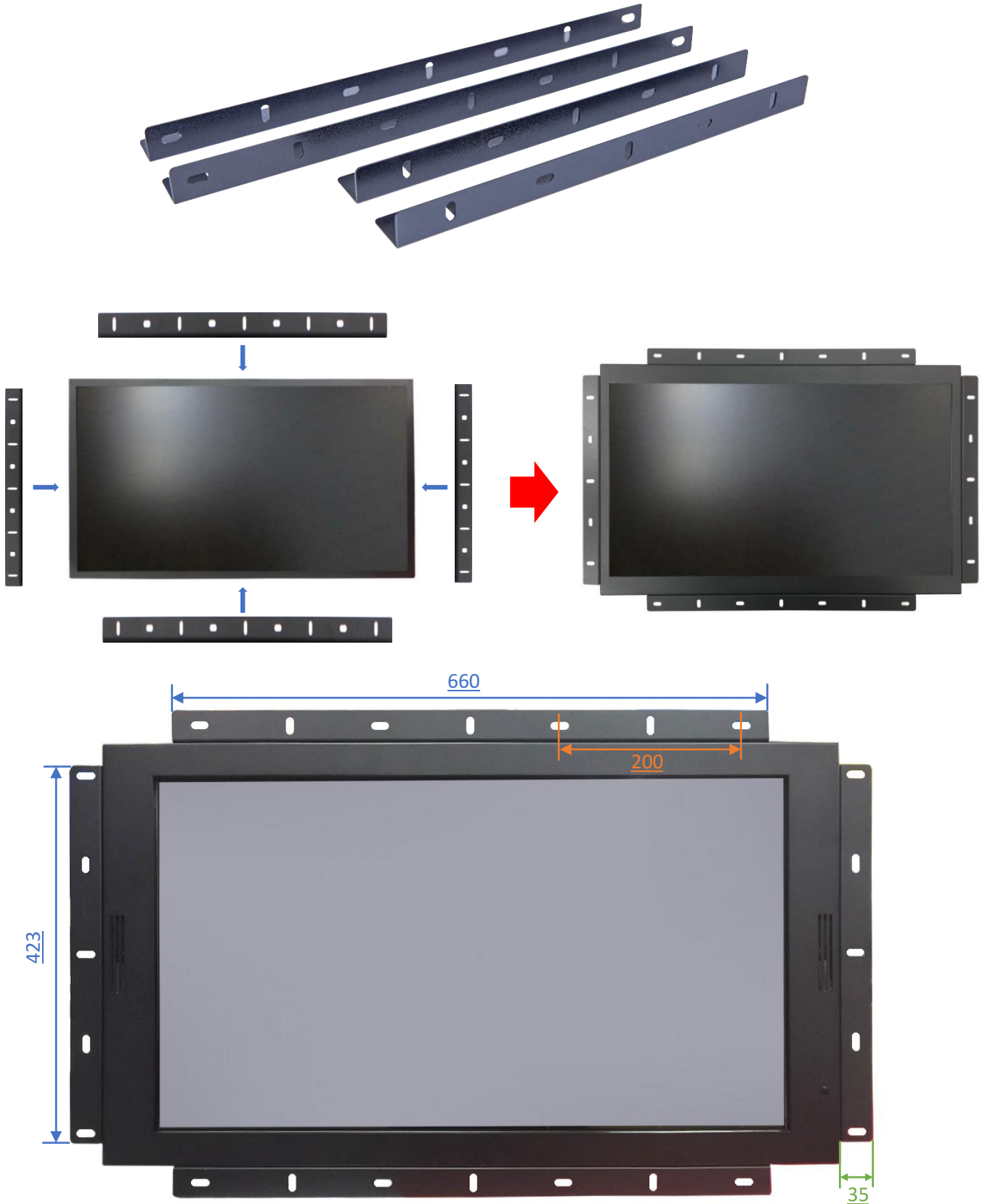

Wall Mount Bracket (Option)

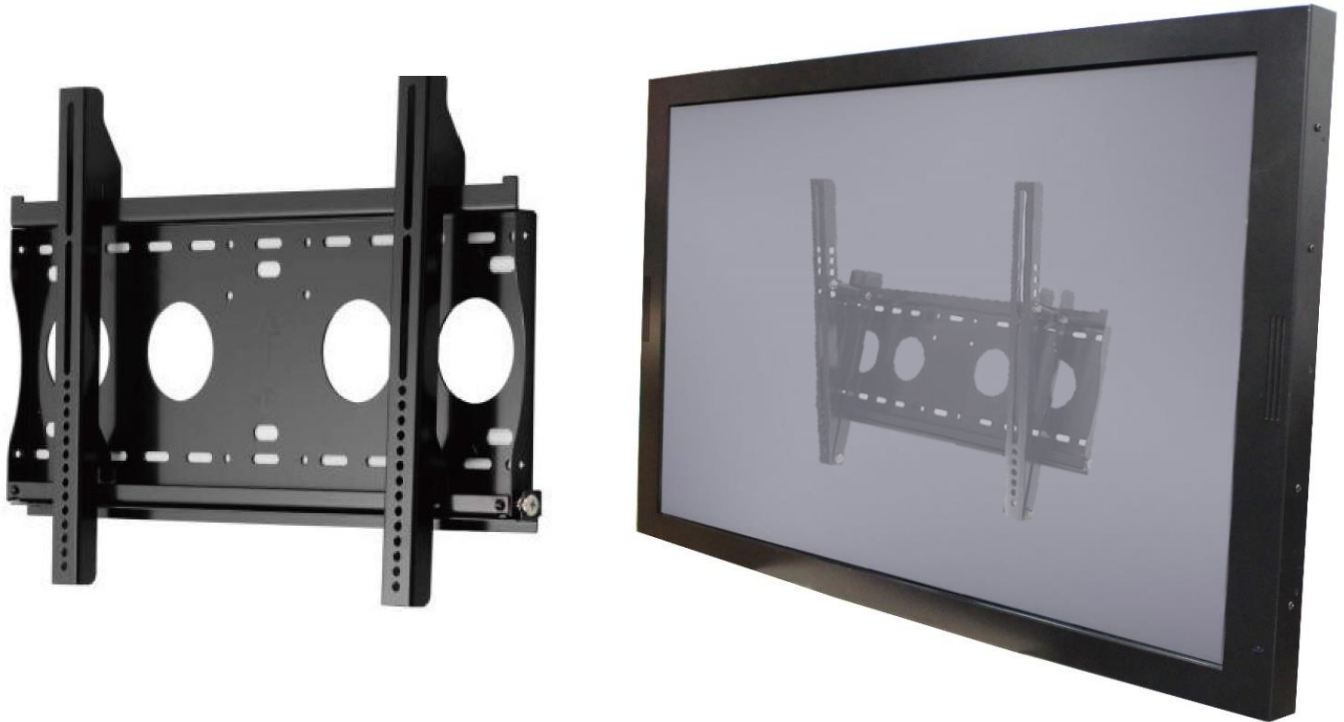

Part No.	WMB-B001		
Mounting Pattern	Max. 400x450 mm	Dimension (WxHxD)	508x490x48 mm
Material	SECC	Net Weight	4.01 KG
Tilt (Hinge)	0°/5°/10°/13°/15°	Support Max. Weight	80 KG
Screw Type	M4/M5/M6/M8	Min. Distance to The Wall	48 mm

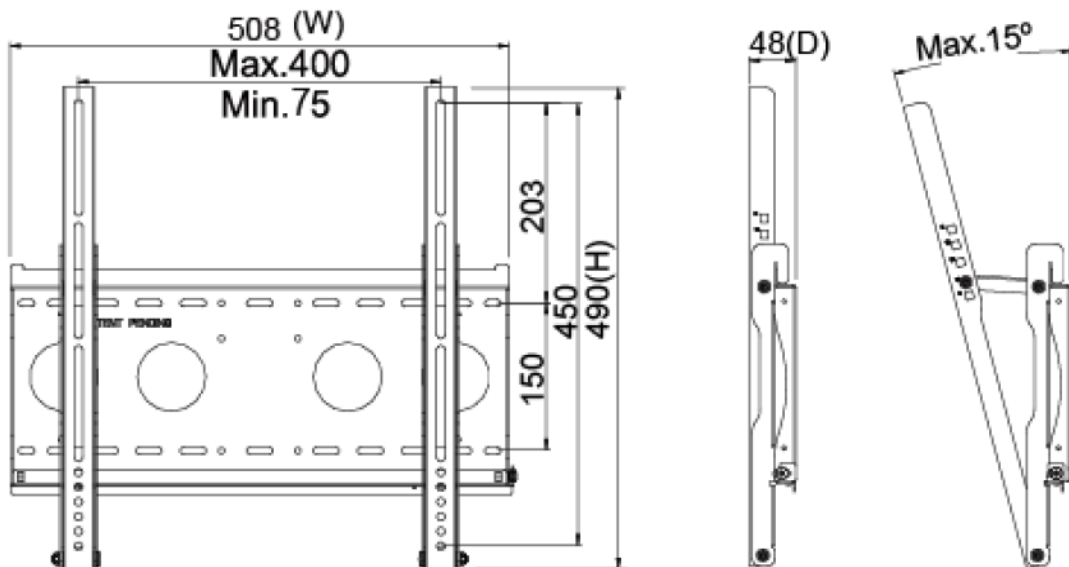

Cart (Option)



Net Weight	32.5 KG
Packaged Dimension	W1160xD833xH1727 mm
Screw Type	M4/M5/M6/M8
Material	Aluminum /Plastic/Steel
Max. Mount Pattern	800x600mm
Max. Weight Load	10~30 KG
Caster	4 (front 2 braking)
Height Adjust Range	500 mm
RoHS/REACH	Yes

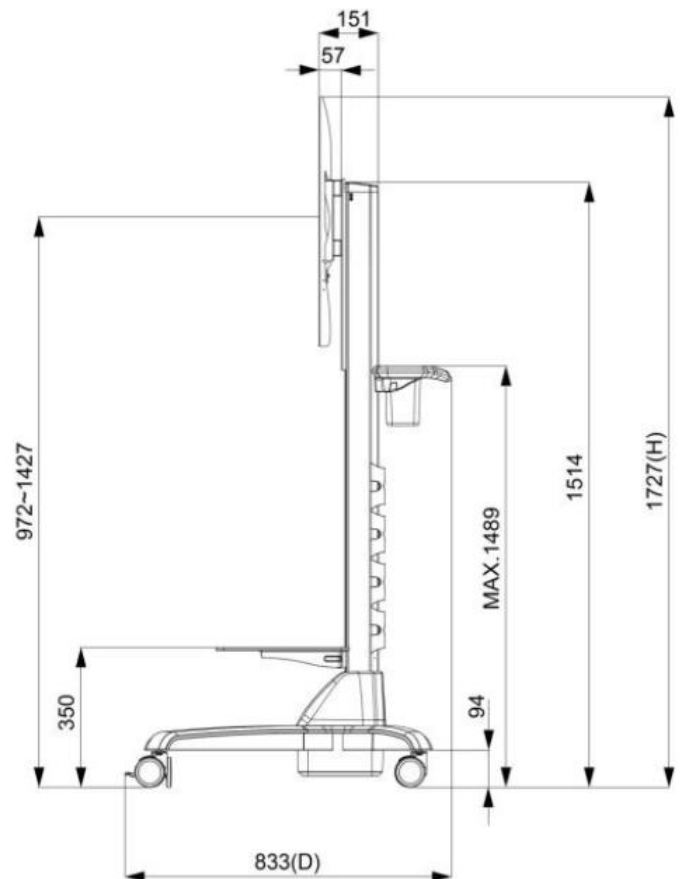
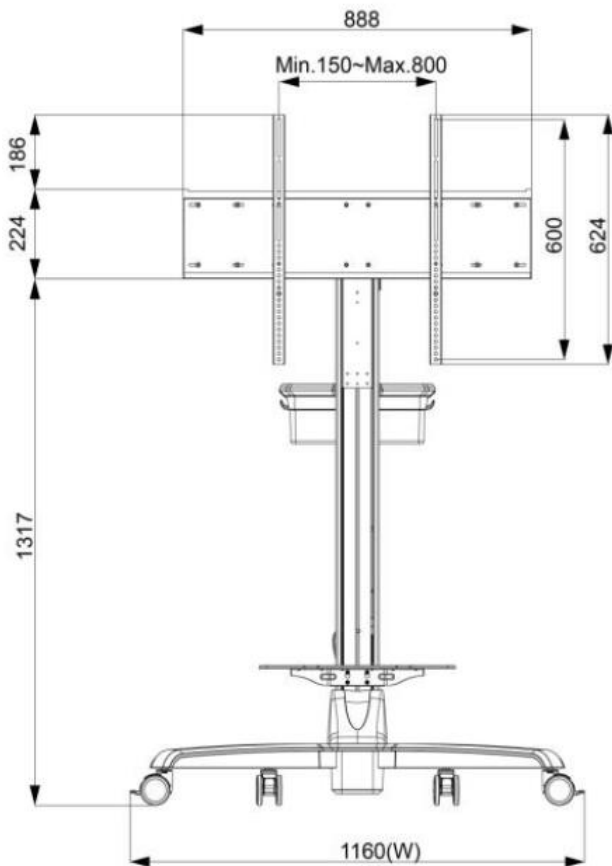

KIOSK Cabinet (Option)



Material	SECC
Caster	4 (front 2 braking)
IP Rating	Front IP65
Power Panel	n/a



Physical Specifications

Dimension (Max)	815x473x73(±1)mm	Net Weight	≤19 KG
VESA Mounting	200x200 mm	Gross Weight	≤22 KG

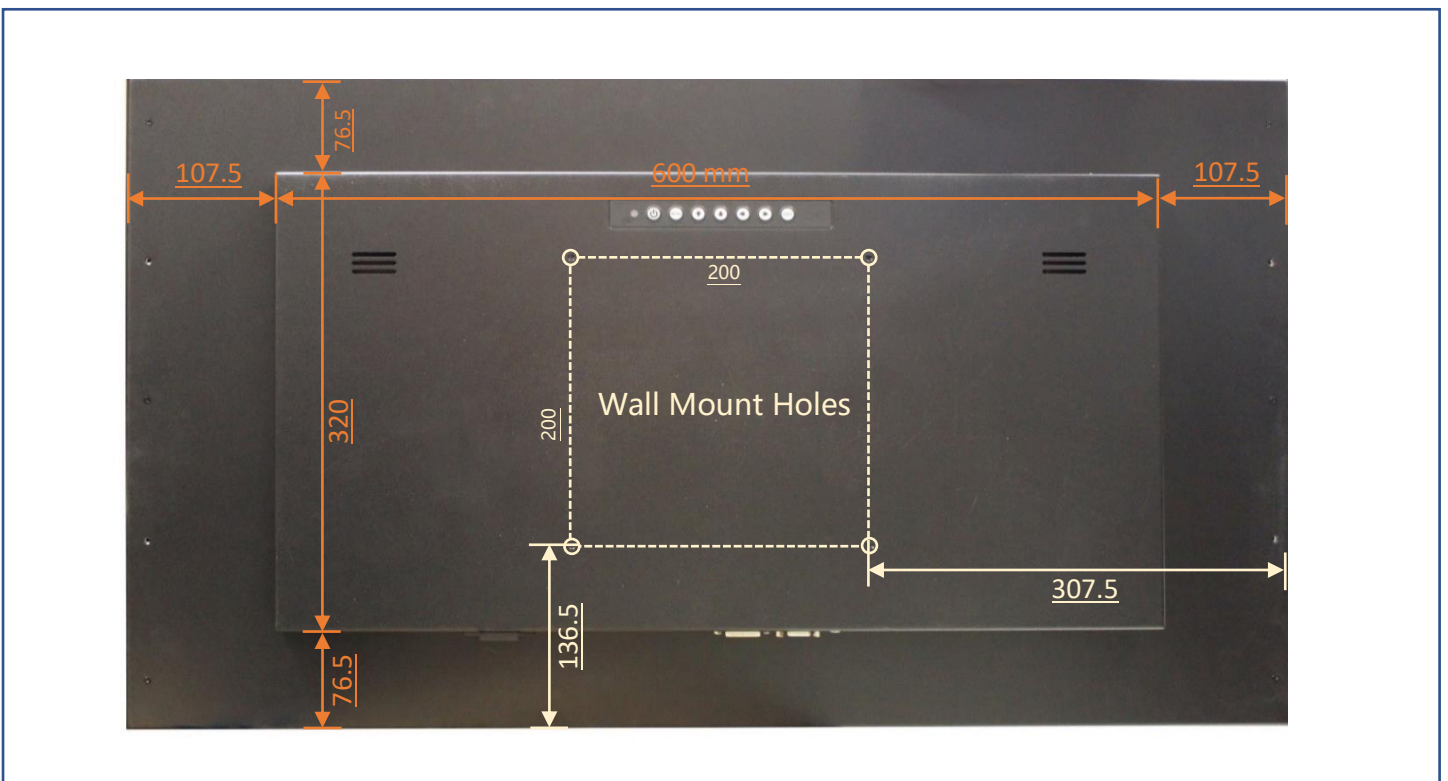

Packing Information



Dimensions of Carton	995x700x230 mm
Net Weight	≤ 19 KG
Gross Weight	≤ 22 KG