



Product Specifications

Customer	
Model	NTI320 V001



Records of Revision			
Vision	Modifying	Old Description	New Description
v1803.1	Preliminary Specifications		
v1803.4	Revise Dimensions		

Features

- ★ 32" 16:9 ,1920x1080 (Full-HD) Resolution
- ★ VA Wide Viewing Angel 178°/178°
- ★ I.R. Touch Option, 7H Hardness Tempered Cover Glass
- ★ 10 points Multi-touch
- ★ Metal Cabinet with Diverse Combine Options
- ★ Made in Taiwan, 3 Years Warranty, Designed for Harsh Environments
- ★ Optional High Brightness/Sunlight Readable
- ★ Media Play by USB Drive. (PC free!)



PSE



BSMI



FCC



CE



RoHS



ISO9001



Display Specifications

Model Name	NTI320X0XXXXA-001 *	Display Mode	VA, Normally Black
Screen Diagonal	31.5 inch	Response Time	10 msec.
Display Area	698.4x392.9 mm	Backlight Unit	LED (white LED)
Resolution	1920x1080 (FHD)	Viewing Angle (L/R, U/D)	178°/178° (CR≥10)
Contrast Ratio	4000:1	Backlight Lifetime	>50,000 Hours
Display Ratio	16:9	Operating Temp.	0~50°C
Support Color	16.7M Colors	Storage Temp.	-20~60°C
Pixel Pitch	0.3637x0.3637 mm	Surface Treatment	AG Haze 2%, Hardness 3H

* X = A~Z, 0~9(Depends on options)

Touch Options

I.R. Touch			
Model Name	NTI320I0XUXXA-001		
Touch Technology	I.R. Touch	Transparency	≥92%
Allowed Touch Points	10 points	Accuracy	99.00%
Interface	USB	Thickness of Cover Lens	4.0±0.2mm
IK Ratings	IK07	Hardness of Cover Lens	7H

Non-Touch	
Model No.	NTI320O0X0XXA-001

Supported OS

Windows	Win7, Win8, Win10 ↑
Linux	Kernel 2.6.24 ↑
Android	3.0 ↑
Mac	10.5.x ↑ (Intel CPU)



General Options

Color of Cabinet		
	Description	Model Name
Standard	Black	NTI320X0BXXXA-001
Option 1	White	NTI320X0WXXXA-001
Option 2	Silver	NTI320X0SXXXA-001
Options	Other Colors	NTI320X0XXXXA-001

* X = A~Z, 0~9 (Depends on Color)

Touch Interface		
	Description	Model Name
Standard	USB	NTI320I0XUXXA-001
Option	Non-Touch	NTI320X0X0XXA-001

Brightness			
	Brightness	Environment	Model Name
Standard	500 nits	General	NTI320X0XXNXA-001
Option 1	1500 nits	Outdoor Environment	NTI320X0XXHXA-031
Option 2	2500 nits	Sunlight Readable	NTI320X0XXHXA-021

* Check the data sheets NTI320 V031/V021

Material of Cabinet		
	Description	Model Name
Standard	SECC	NTI320X0XXXSA-001
Option 1	Stainless Steel	NTI320X0XXXLA-001
Option 2	Aluminum	NTI320X0XXXAA-001

Accessories

Item	Description	Quantity
HDMI Cable	HDMI Male to Male, 1.5 Meter	1
Power cord	*Country Specific	1
USB Cable	A type, Male to Male, 1.5 Meter *(only for touch monitor)	1

Display Input

Connectors	Description	Connectors	Description
VGA	15pin D-Sub x1	DVI	DVI-I x1
HDMI	HDMI 1.4 x2	USB	USB Type A x1 *

* For media playing function by using USB drives, plays the media files automatically.

Supported Media Format	
Movie	avi, mpg, dat, vob, mov, mkv, rm, rmvb, mp4, mjpeg, ts, trp, wmv, asf, flv
Picture	Jpg, bmp, png
Music	mp3, m4a

Notes

1. Media playing function by using USB driver isn't supporting touch function.
2. Touch function requires a PC, Android or Linux device.
3. Media playing function requires an USB Drive only. (without PC)

Audio System

	Description	Connector
Audio Input	Stereo	TRS Connector Φ 3.5mm (Earphone Jack)
Speakers	10W x2	



Input /Output System

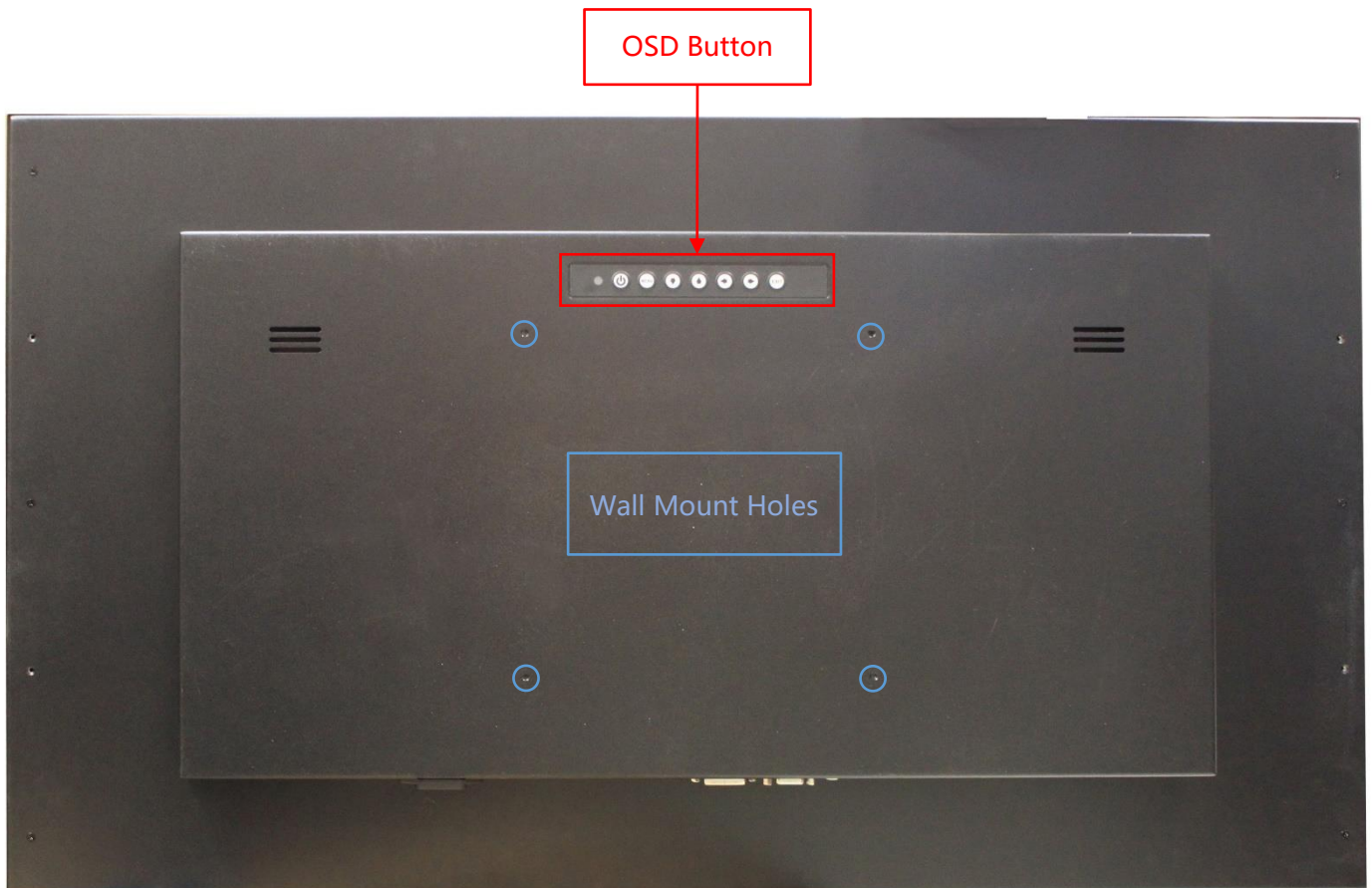
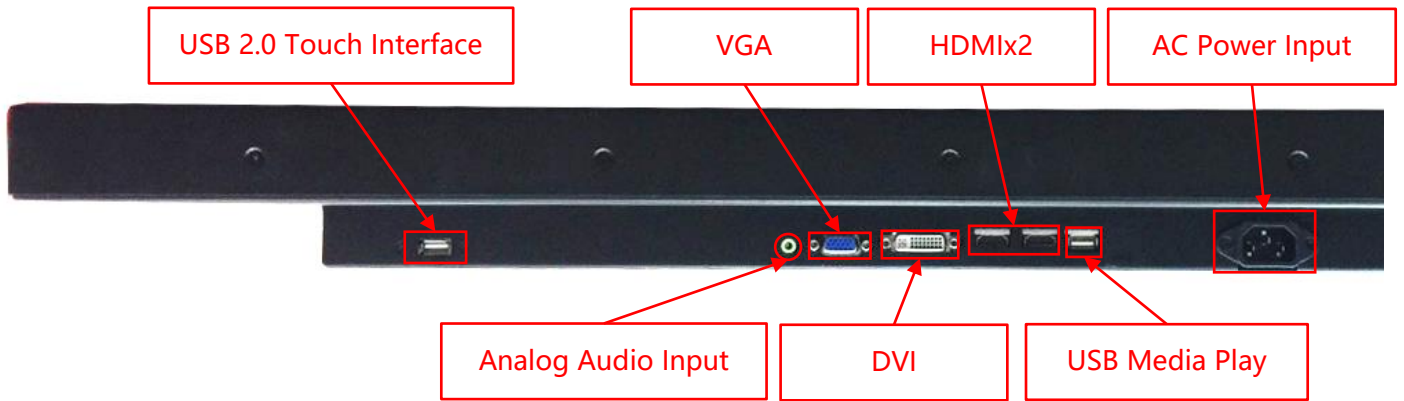

Open-frame Brackets (Option)

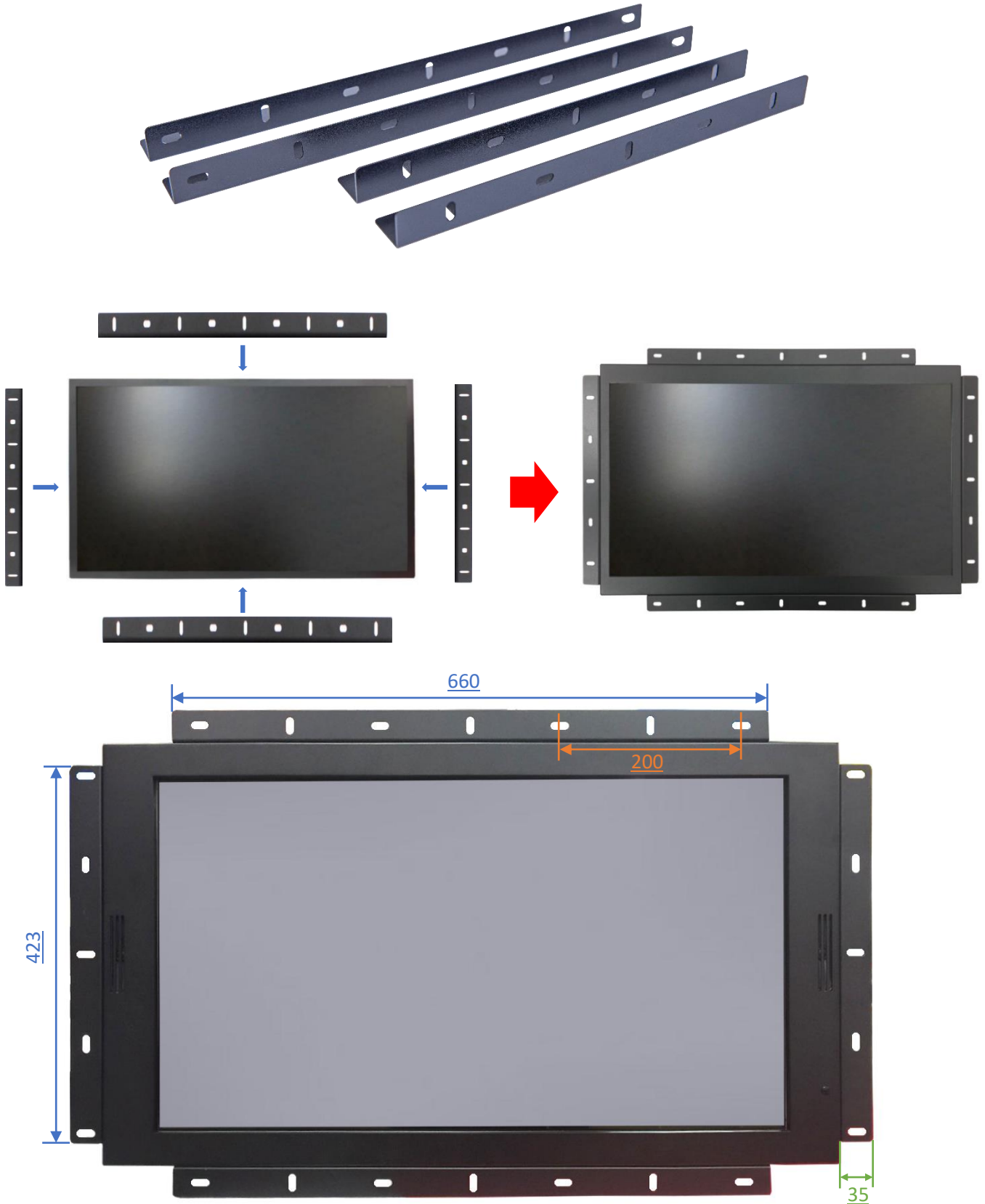

Wall Mount Bracket (Option)

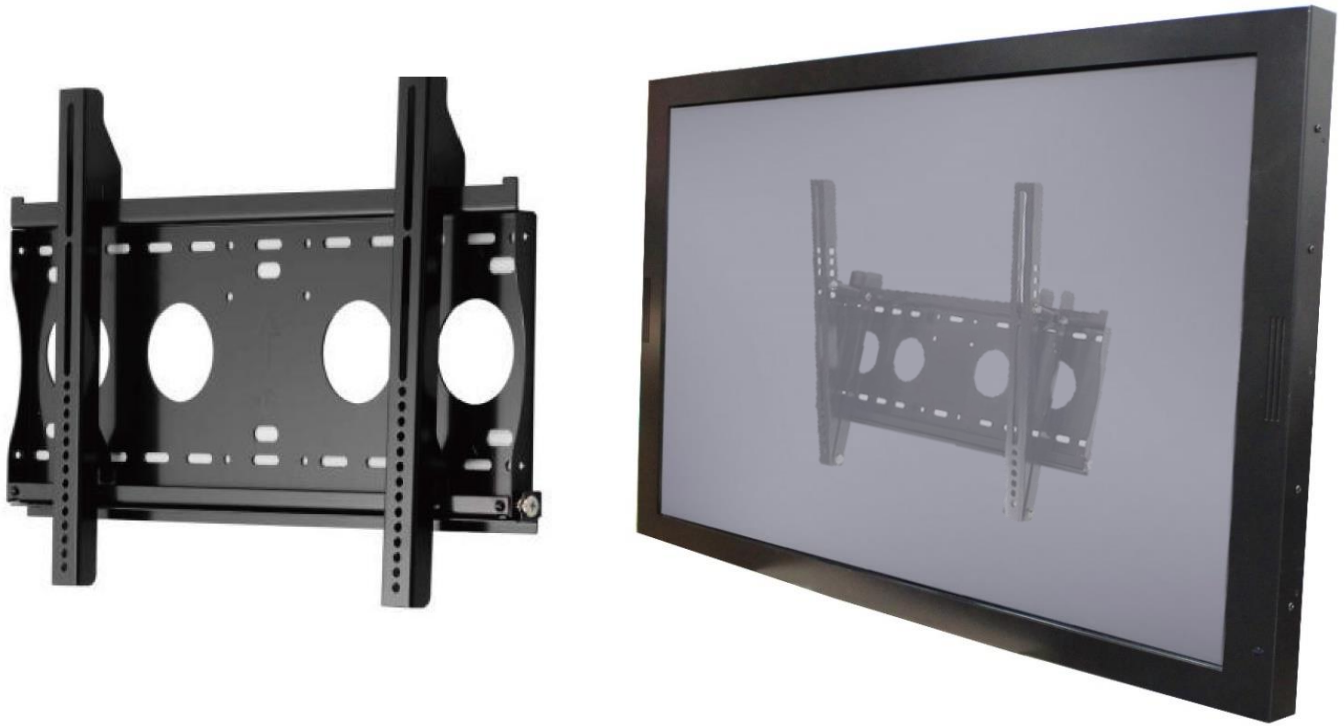

Part No.	WMB-B001		
Mounting Pattern	Max. 400x450 mm	Dimension (WxHxD)	508x490x48 mm
Material	SECC	Net Weight	4.01 KG
Tilt (Hinge)	0°/5°/10°/13°/15°	Support Max. Weight	80 KG
Screw Type	M4/M5/M6/M8	Min. Distance to The Wall	48 mm

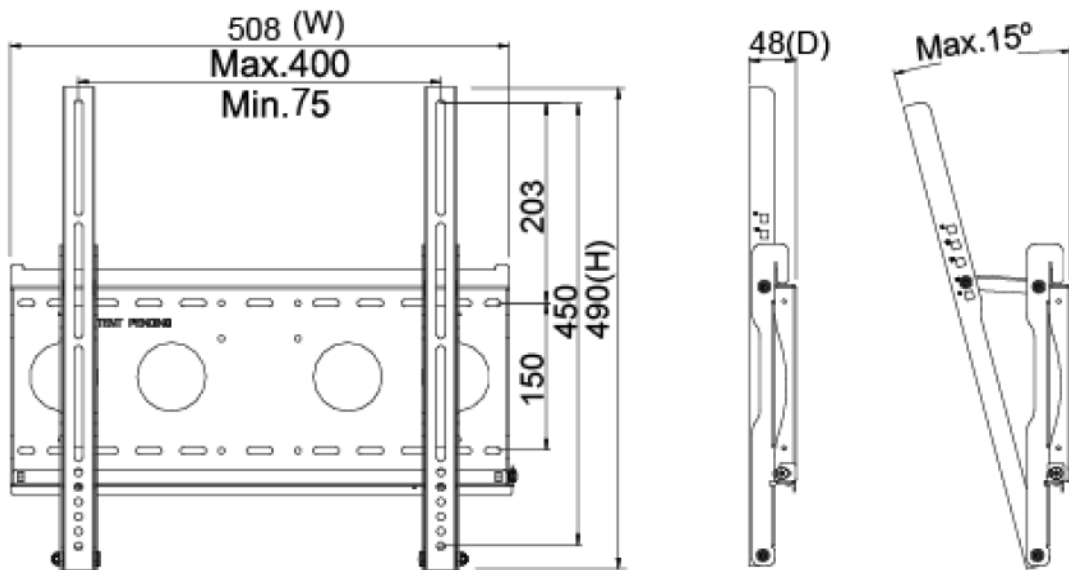

Cart (Option)



Net Weight	32.5 KG
Packaged Dimension	W1160xD833xH1727 mm
Screw Type	M4/M5/M6/M8
Material	Aluminum /Plastic/Steel
Max. Mount Pattern	800x600mm
Max. Weight Load	10~30 KG
Caster	4 (front 2 braking)
Height Adjust Range	500 mm
RoHS/REACH	Yes

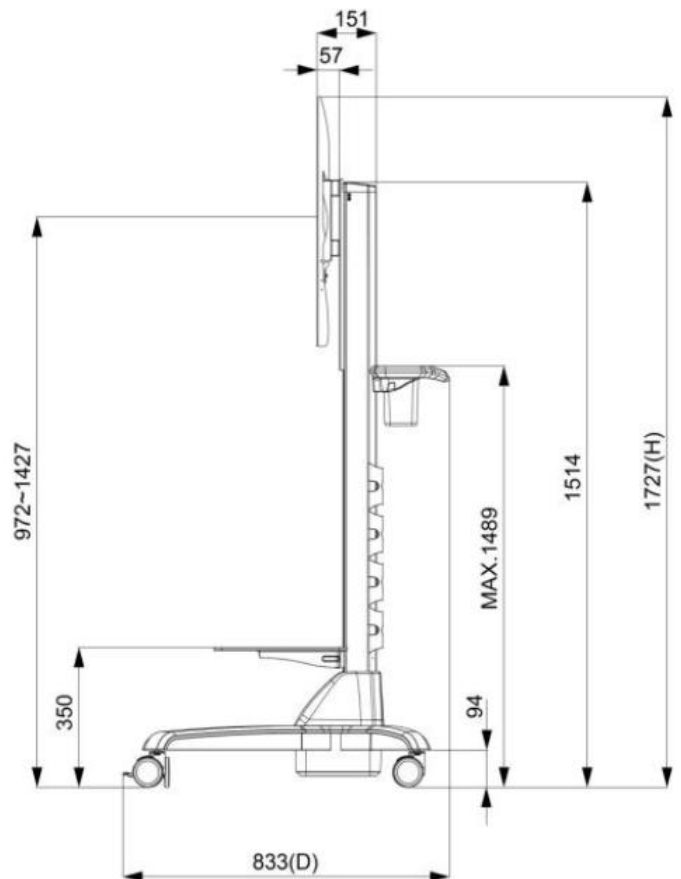
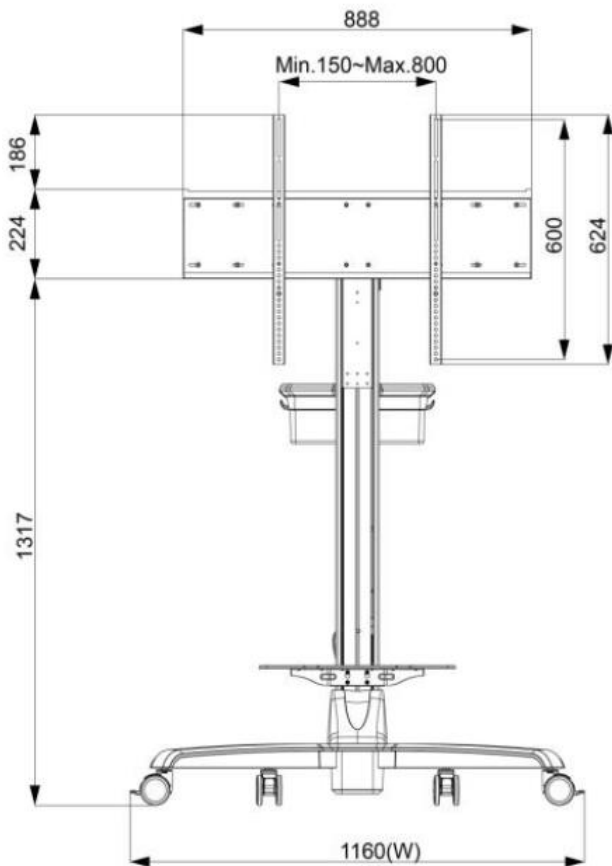

KIOSK Cabinet (Option)



Material	SECC
Caster	4 (front 2 braking)
IP Rating	Front IP65
Power Panel	n/a



Physical Specifications

Dimension (Max)	815x473x73(±1)mm	Net Weight	≤19 KG
VESA Mounting	200x200 mm	Gross Weight	≤22 KG

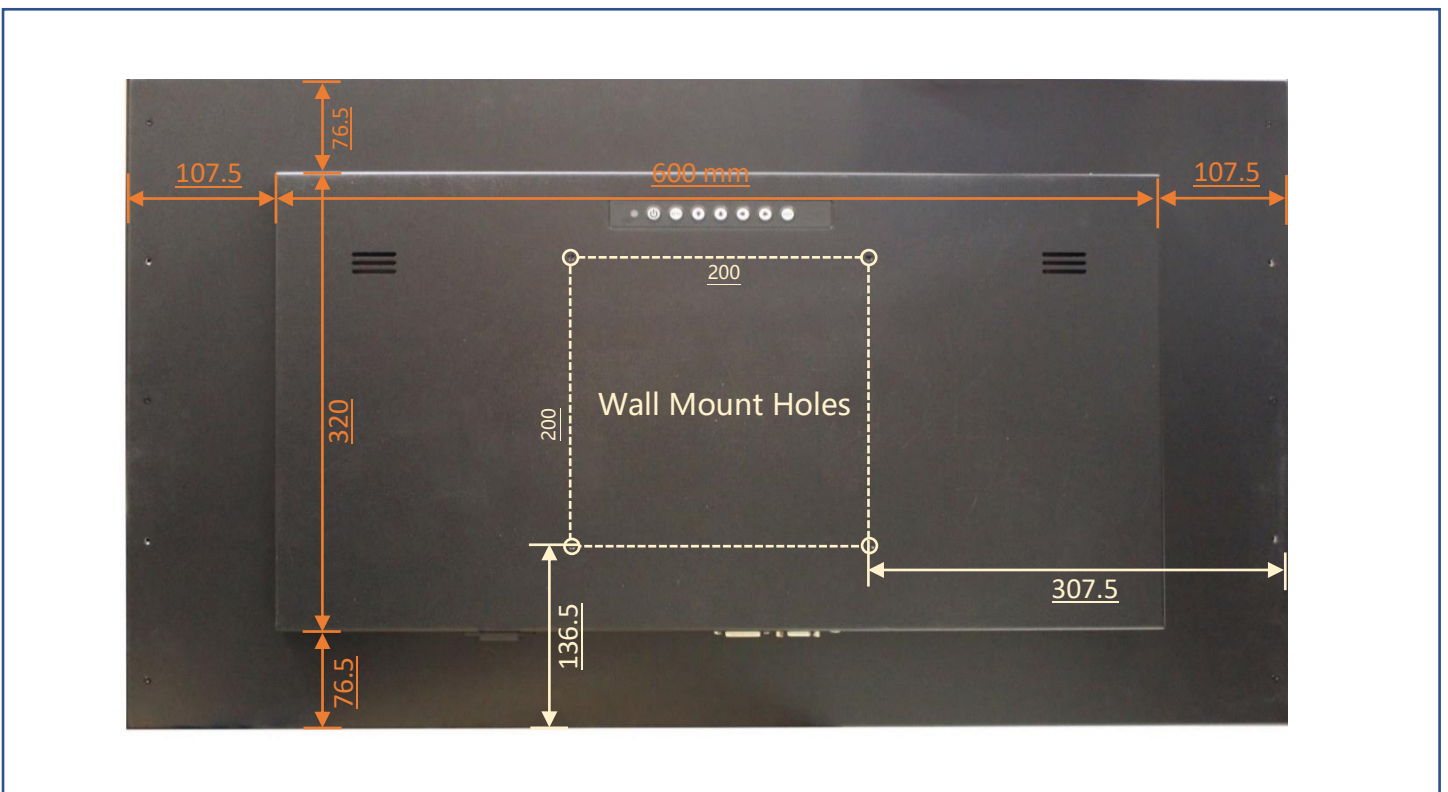

Packing Information



Dimensions of Carton	995x700x230 mm
Net Weight	≤ 19 KG
Gross Weight	≤ 22 KG