

# Product Specifications

<b>Customer</b>	
<b>Model</b>	<b>NTAP238-2-Q3 V500</b>
<b>Model No.</b>	<b>NTAP238<u>XX2XX</u>-Q3A84FA-<u>XXXX</u>-500</b>

\* X = A~Z, 0~9 (Depends on Options.)



Records of Revision			
Vision	Modifying	Old Description	New Description
v2112.1	Preliminary specification		
v2112.2	Android version upgraded	Android 9	Android 10
v2112.3	Stylus pen option added		
v2112.4	Carton modified		
v2112.5	New trademark released		
<b>v2112.6</b>	<b>Hardware upgraded</b>	<b>DDR3 Memory Wi-Fi 5</b>	<b>DDR4 Memory Wi-Fi 6</b>

# Nextech P Series 23.8" Android All-in-one Industrial Touch PC

**NTAP238-2-Q3 V500**

## Features

- ★ 23.8 inch Industrial Grade Panel, 1920x1080 (FHD) Resolution
- ★ AHVA Wide Viewing Angle Technology (178°/178°)
- ★ Rock Chip ARM Cortex A72+A53 RK3399 Quad-Core CPU
- ★ On Board DDR4 4G Memory
- ★ On Board 16G Flash ROM (Max. upgraded to 32G)
- ★ Micro SD Card Slot x1 (Max. to 64G)
- ★ Android 10.0
- ★ Narrow Bezel, True Flat Projected Capacitive Touch Screen
- ★ 7H Hardness Tempered Cover Glass
- ★ 10 points Multi-touch, Supports NEXTECH Dedicated Stylus
- ★ Metal Cabinet with Diverse Combine Options
- ★ Made in Taiwan, 3 Years Warranty
- ★ Optional High Brightness 1500nits, for Outdoor Environment
- ★ Optional AG Coating/Antibacterial/Privacy Filter Surface Treatment



PSE



BSMI



RoHS



CE



ISO9001



FCC

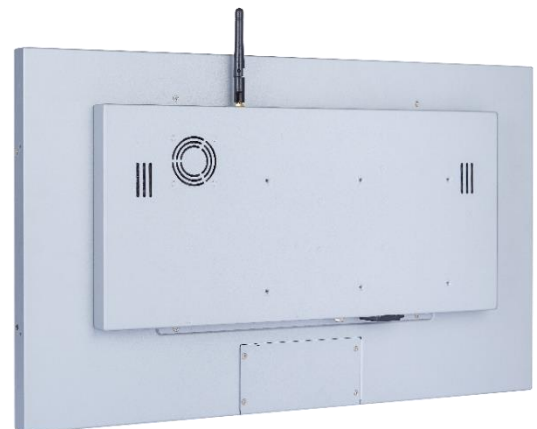

Desktop Stand



Wall Mounting



Open-frame Brackets



Panel Mount

## System Specifications

CPU	Dual Core ARM Cortex-A72 +Cortex-A53 up to 2.0GHz
Memory	Samsung LPDDR4 4G
Storage	Samsung 16G EMMC Flash ROM (Max. to 32G)
GPU Chip	Mali-T860 GPU
Sound Chip	Realtek ALC662 Audio CODEC
Physical Network	1x GbE Lan port (RJ45)
Wireless Network	Wi-Fi 6 and Blue Tooth v2.1+EDR/V3.0/V3.0+HS/V4.0
OS	Android 10.0

## Display Specifications

Screen Diagonal	23.8 inch	Display Mode	AHVA Mode, Normally Black
Display Area	527.04x296.46 mm	Backlight Unit	LED (white LED)
Resolution	1920x1080 (FHD)	Viewing Angle (L/R, U/D)	178°/178° (CR=10)
Contrast Ratio	1000:1	Response Time	14 msec.
Display Ratio	16:9	Backlight Lifetime	>50,000 Hours
Support Colors	16.7M Colors	Operating Temp.	0~50°C
Pixel Pitch	274.5x274.5 um	Storage Temp.	-20~60°C

## Display Options

Brightness			
	Brightness	Environment	Model Name
Standard	400nits	General	NTAP238 <b>N</b> X2XX-Q3A84FA- <u>XXXX</u> -500
Option 1	1000nits	Outdoor Environment	NTAP238 <b>A</b> X2XX-Q3A84FA- <u>XXFX</u> -500
Option 2	1500nits	Sunlight Readable	NTAP238 <b>F</b> X2XX-Q3A84FA- <u>XXFX</u> -500

# Nextech P Series 23.8" Android All-in-one Industrial Touch PC

**NTAP238-2-Q3 V500**

## Touch Options

Projected Capacitive			
Model Name	NTAP238X <u>P2XX</u> -Q3A84FA- <u>XXXX</u> -500		
Touch Technology	Projected Capacitive	Thickness of Cover Lens	2.9±0.2mm
Allowed Touch Points	10 points	Hardness of Cover Lens	7H
Transparency	≥87%	IK Ratings	IK07
Accuracy	99.00%		

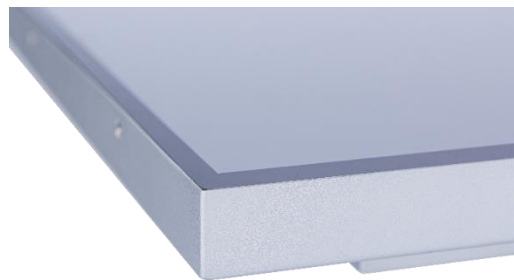

\* True Flat, 1mm Bezel

Non-Touch	
Model Name	NTAP238X <u>02XX</u> -Q3A84FA- <u>XXXX</u> -500

Surface Treatment		
	Description	Model Name
<b>Standard</b>	<b>(none)</b>	<b>NTAP238XX2<u>00</u>-Q3A84FA-<u>XXXX</u>-500</b>
Option 1	Anti-Glare Coating	NTAP238XX2 <u>GG</u> -Q3A84FA- <u>XXXX</u> -500
Option 2	Antibacterial (AB Film)	NTAP238XX2 <u>AB</u> -Q3A84FA- <u>XXXX</u> -500
Option 3	Anti-Spy (AS Film)	NTAP238XX2 <u>SF</u> -Q3A84FA- <u>XXXX</u> -500

Passive Stylus Pen (Option)	
Technology	Passive High Sensitive Knitted Wire Mesh Fiber Tip
Size of tip	6mm
Magnetic Attachment	Yes



Magnetic Attachment

## System Options

Material of Cabinet		
	Description	Model Name
<b>Standard</b>	<b>SECC</b>	<b>NTAP238XX2XX-Q3A84FA-SXXX-500</b>
Option 1	Stainless Steel	NTAP238XX2XX-Q3A84FA-LXXX-500
Option 2	Aluminum	NTAP238XX2XX-Q3A84FA-AXXX-500

Color of Cabinet		
	Description	Model Name
<b>Standard</b>	<b>Silver</b>	<b>NTAP238XX2XX-Q3A84FA-XSXX-500</b>
Option 1	White	NTAP238XX2XX-Q3A84FA-XWXX-500
Option 2	Black	NTAP238XX2XX-Q3A84FA-XBXX-500
Options	Other Colors	NTAP238XX2XX-Q3A84FA-XXXX-500

\* X = A~Z, 0~9 (Depends on Color)

Cooling Fan		
	Description	Model Name
<b>Standard</b>	<b>Fanless</b>	<b>NTAP238XX2XX-Q3A84FA-XX0X-500</b>
Option	7 Blades/4000r.p.m/28.3dB	NTAP238XX2XX-Q3A84FA-XXFX-500

Power Input		
	Description	Model Name
<b>Standard</b>	<b>12VDC-in, with AC/DC Adapter</b>	<b>NTAP238XX2XX-Q3A84FA-XXX2-500</b>
Option	100~240V AC, C14 AC Power Socket	NTAP238XX2XX-Q3A84FA-XXXA-500



DC-in



AC-in

## Input /Output System

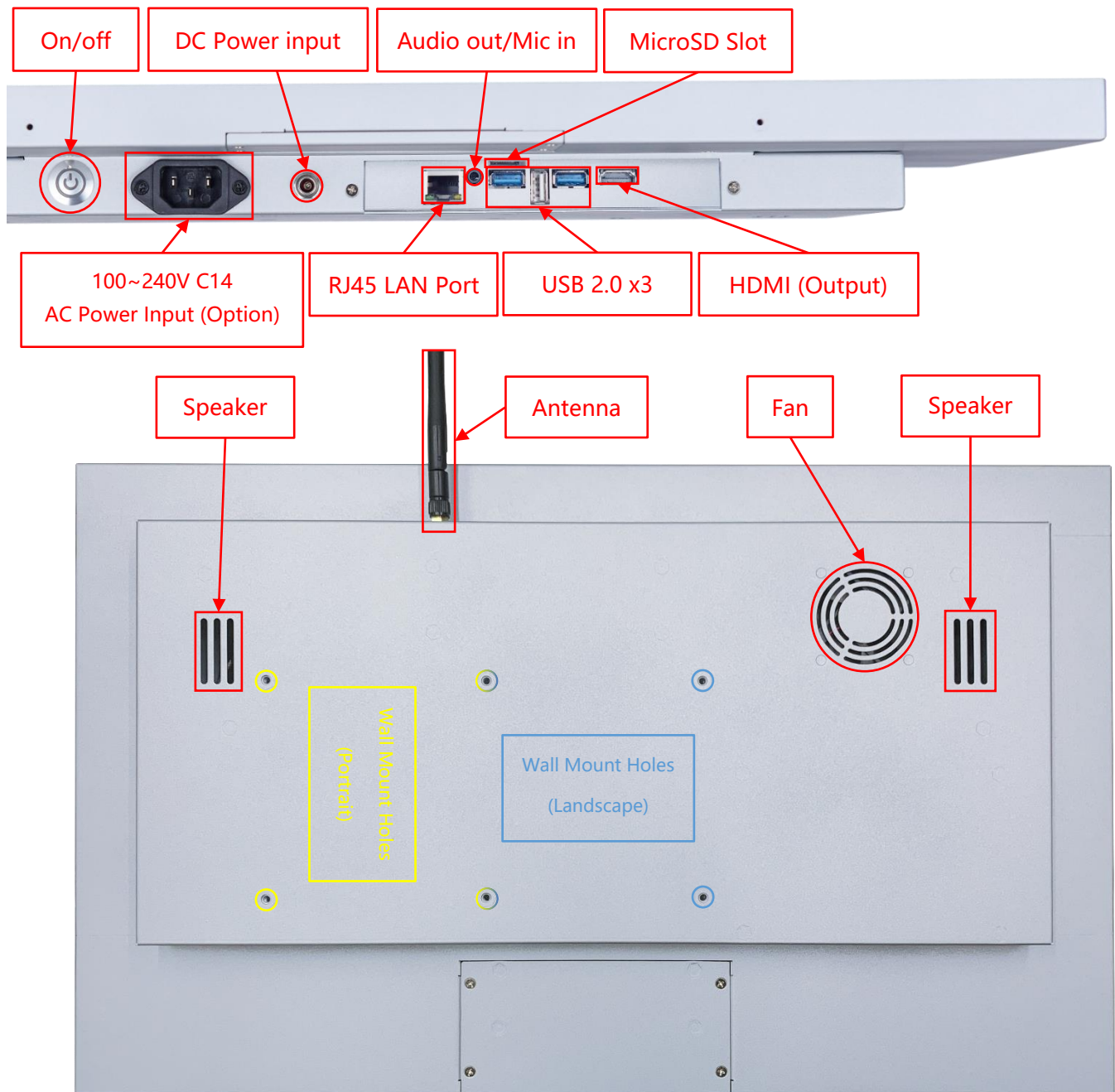

Input / Output	Connectors	Input / Output	Connectors
HDMI (Output)	1	USB 2.0	3
Audio Output /Mic Input (3.5mm)	1	MicroSD Card Slot	1
DC Power Input	1	LAN (RJ45)	1
AC Power Input	Option	Wi-Fi/Bluetooth & Antenna	1
Speakers	2W x2		

## Front Cover (Option)

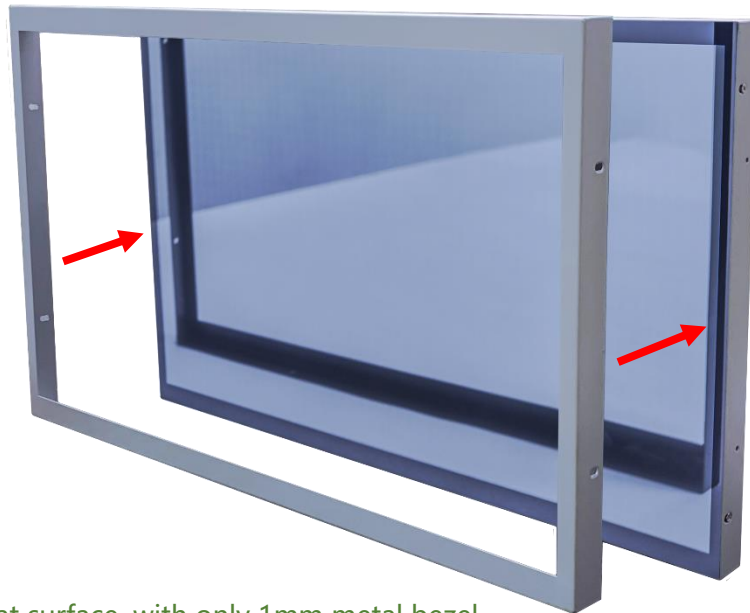

The standard **NTAP238** is true flat surface, with only 1mm metal bezel.  
To protect the corners of the touch screen, the **Front Cover** can be added.



The watertight gasket can be added between the **Front Cover** and **NTAP238**.  
It complies **IP65** on front.

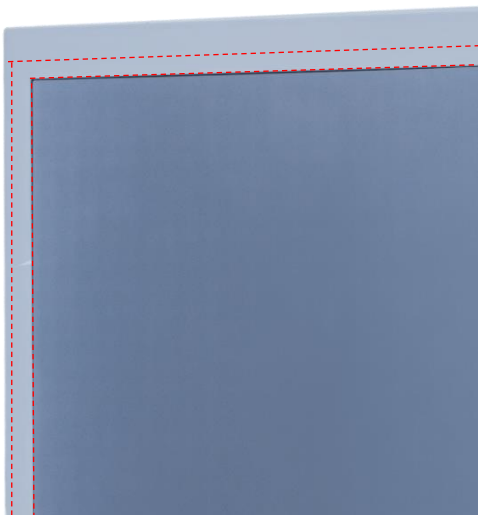

## Open-frame Brackets (Option)

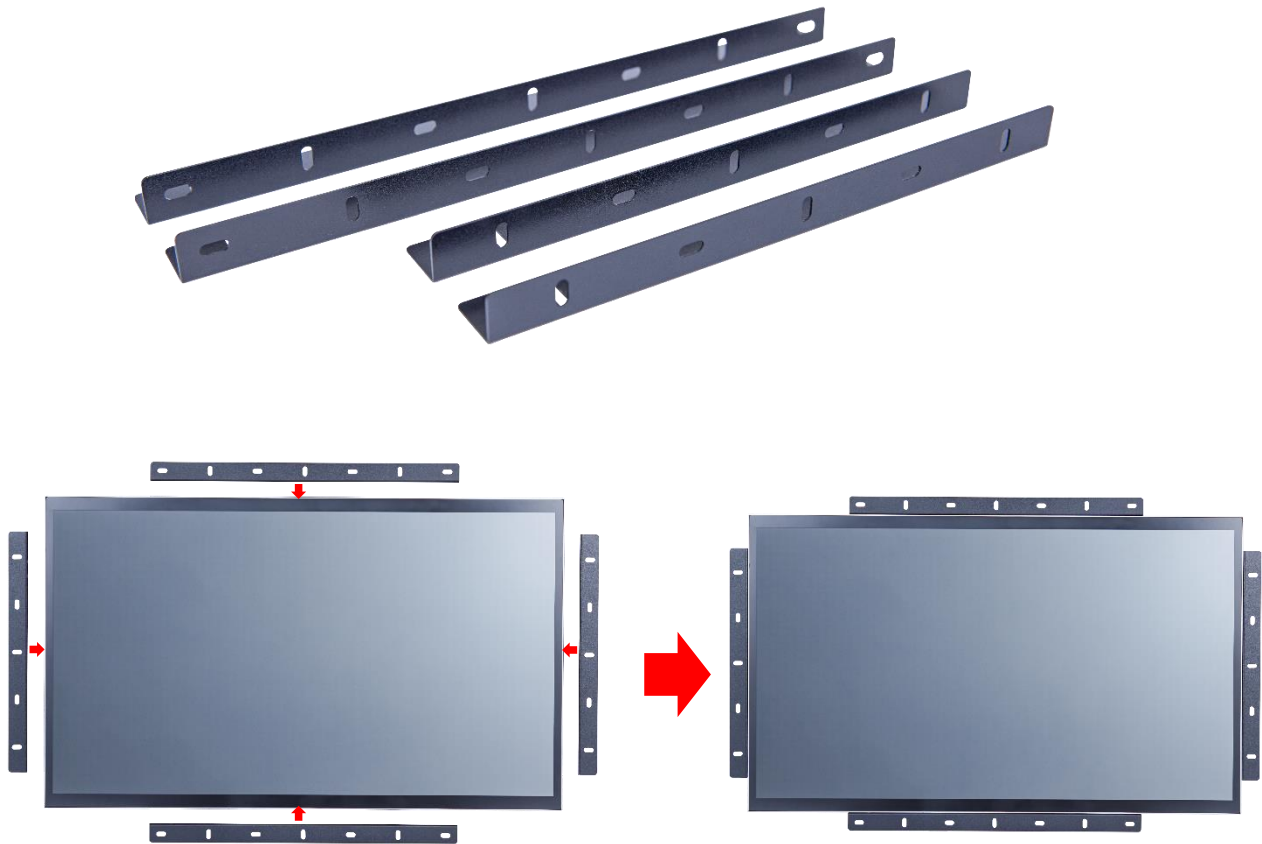

### Dimension for Installing with Open-frame Brackets

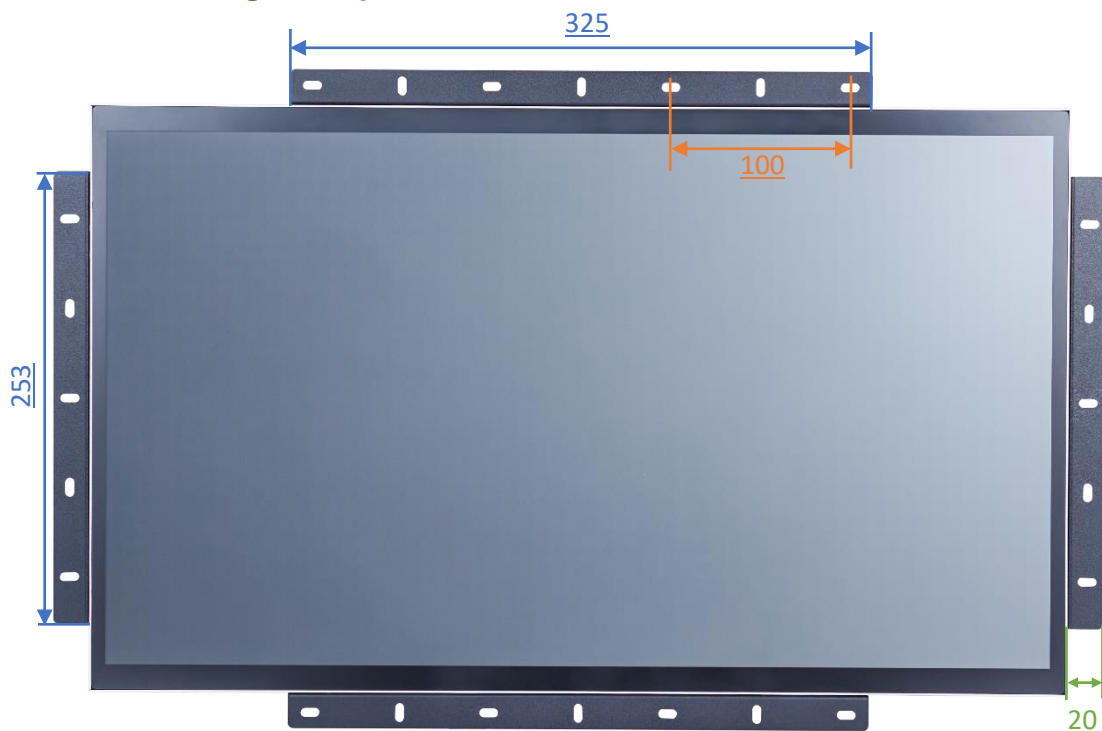



**Panel Mount Kits (Option)**

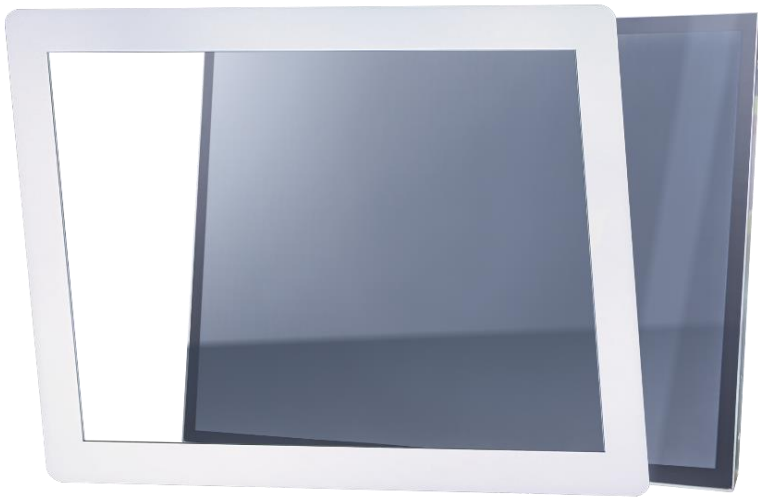

**Dimension for Installing with Panel Mount Kits**

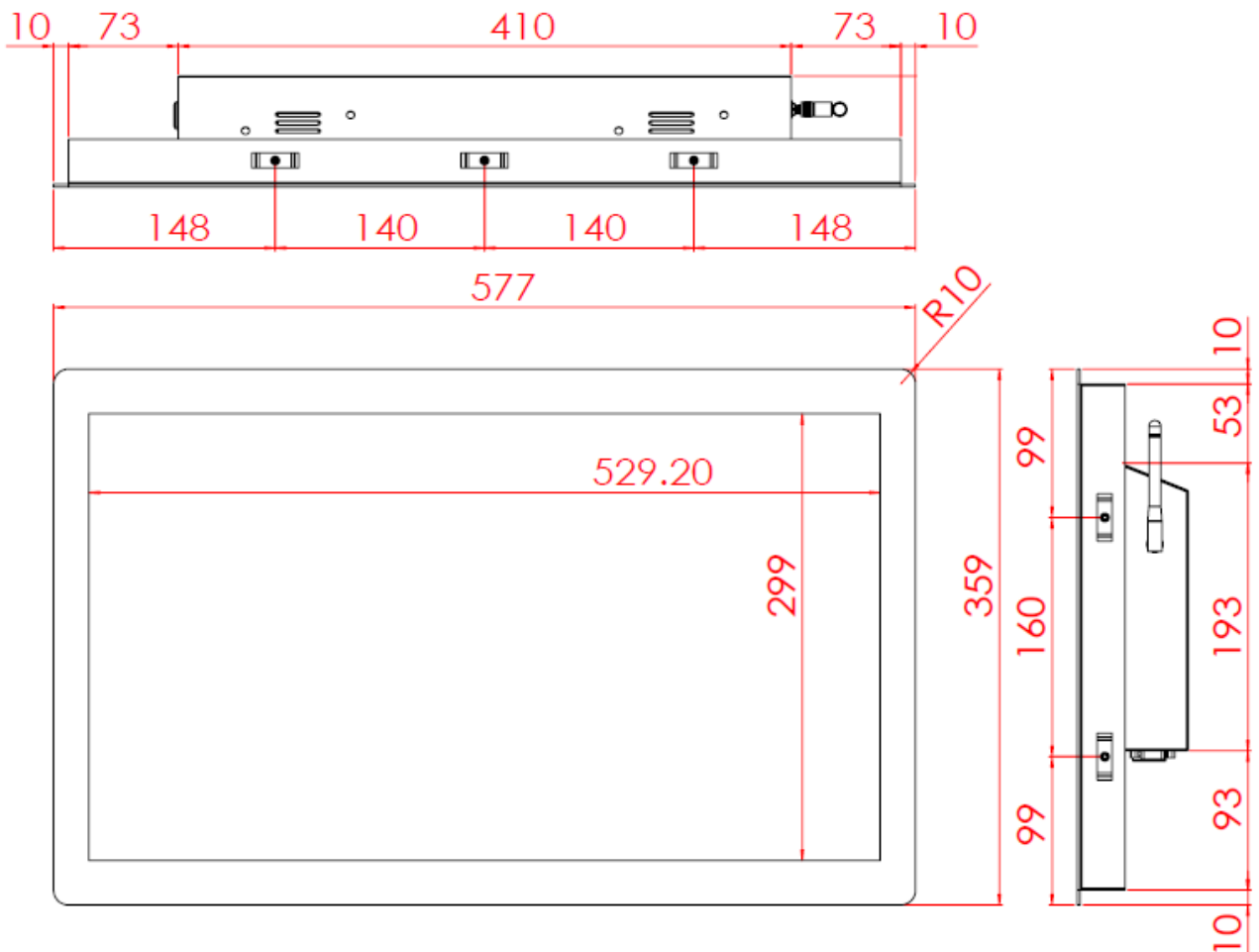

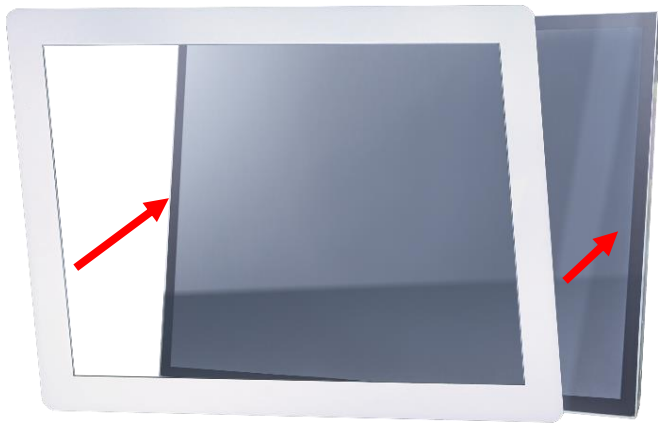

Step 1: Assemble the front module with the screen body. (This step is pre-assembled at the factory.)

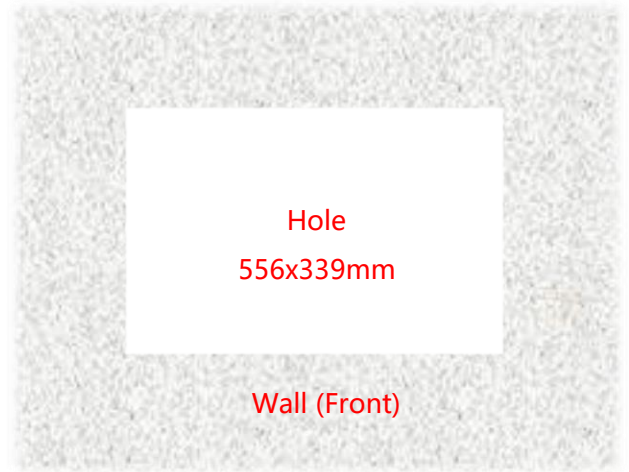

Step 2: Insert the screen from the front into the pre-cut opening.

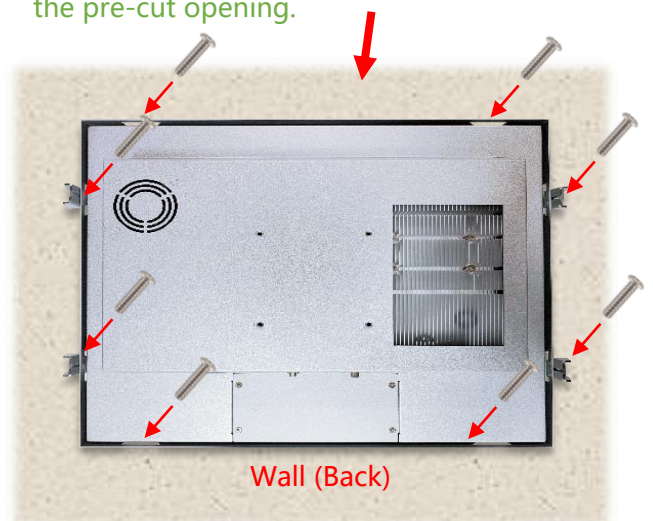

Step 3: Attach the clips from the back and secure with screws. (Up to 9 clips can be installed as needed or per positional limitations.)

### Desktop Stand (Option)

Item	B Stand	Part No.	DST-0B002/DST-1B002
Mounting Pattern	100x100 / 75x75 mm	Dimension (WxHxD)	203x275x227 mm
Material	Steel/Plastic/Aluminum	Net Weight	1.8 KG
Tilt (Hinge)	-2° ~ +180°	Support Max. Weight	15 KG



Item	Z Stand	Part No.	DST-0BZ01/DST-1BZ01
Mounting Pattern	100x100 / 75x75 mm	Dimension (WxHxD)	190x240x41.6
Material	SECC	Net Weight	2.6 KG
Tilt (Hinge)	±360°	Support Max. Weight	15 KG

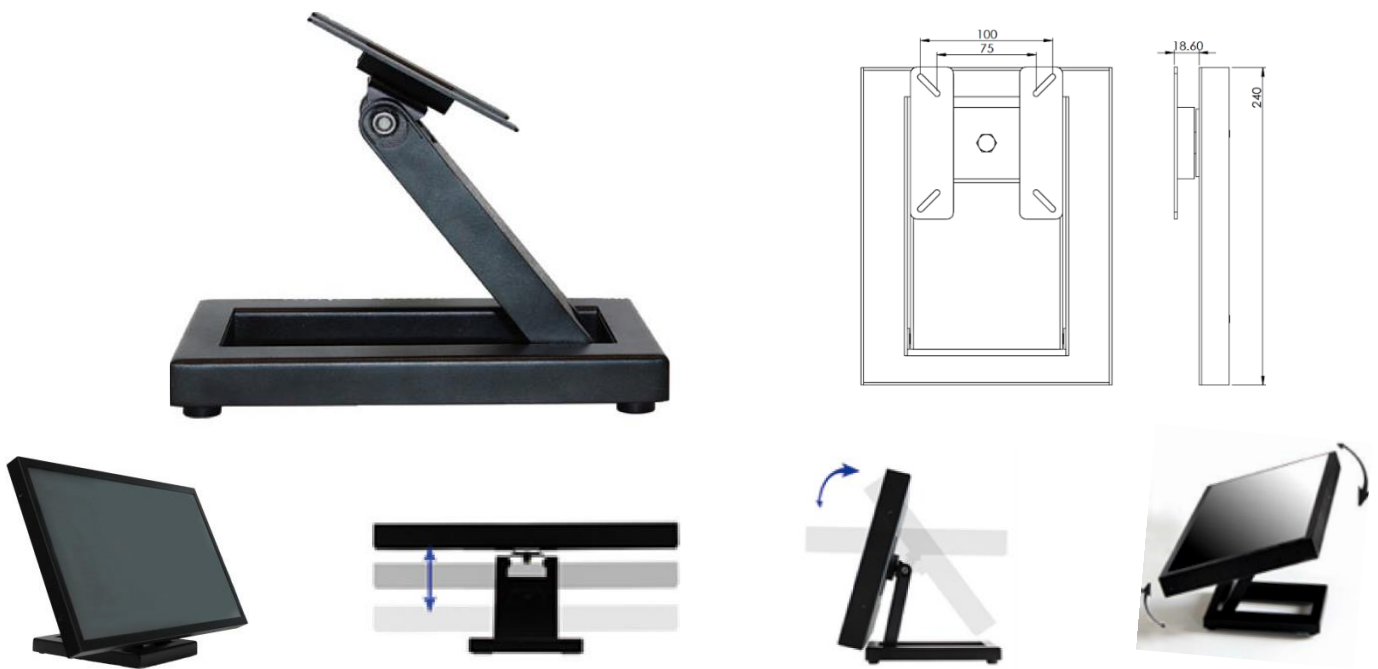

## Wall Mount Bracket (Option)

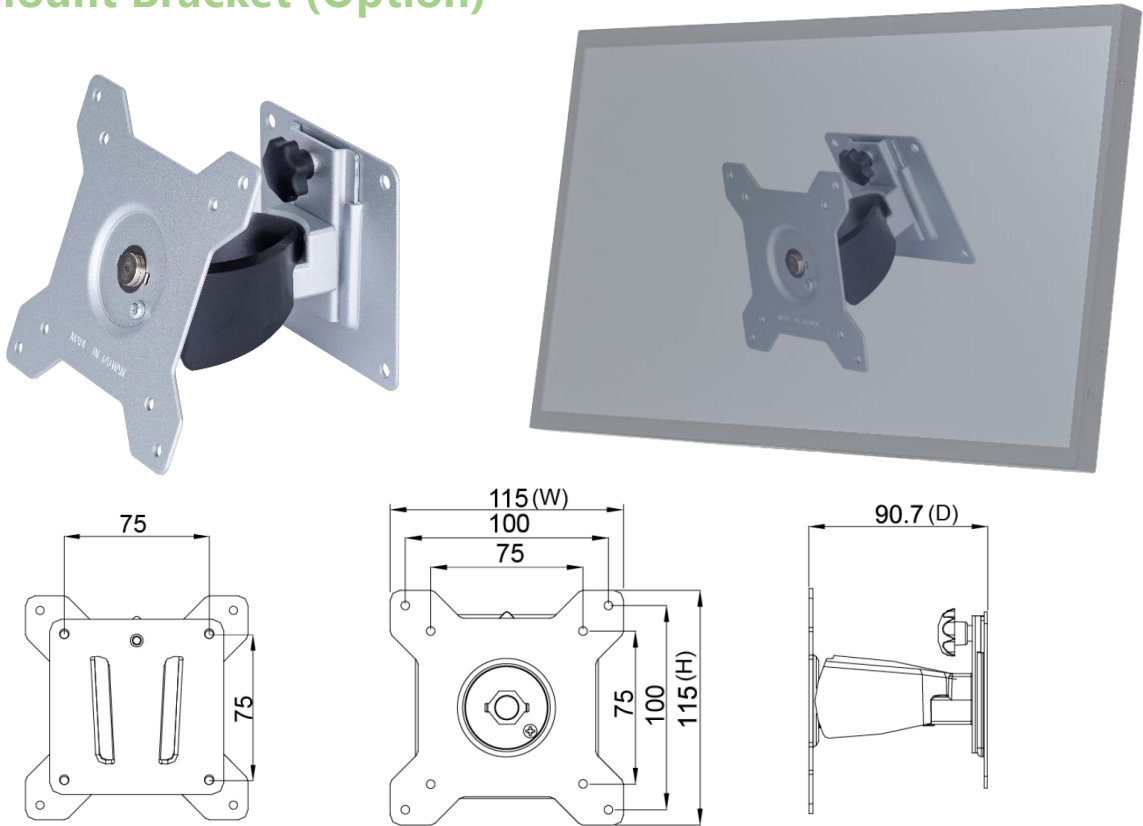

## Packing Information



Unit Carton Size	<b>665x160x510 mm</b>
Unit N. Weight	<b>≤5.9 KG</b>
Unit G. Weight	<b>≤7.9 KG</b>
Units per Pallet	<b>30 units</b>
Pallet Size	<b>120x100x171 CM</b>

## Physical Specifications

Dimension	<b>547x329x48(±2)mm (W/O Antenna)</b>	Net Weight	<b>≤5.9 KG</b>
VESA Mounting	<b>100x100 mm</b>	Gross Weight	<b>≤7.9 KG</b>

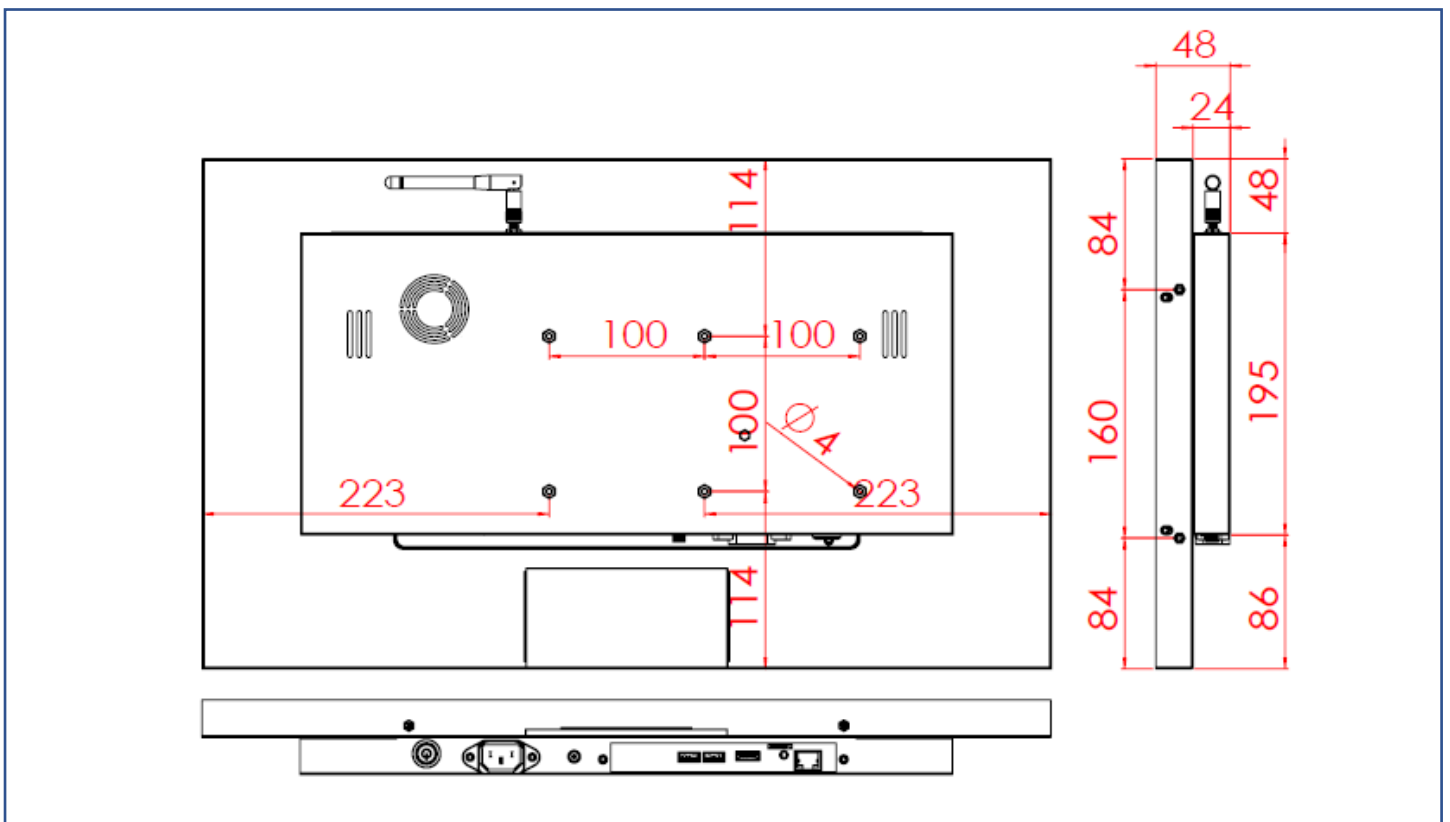
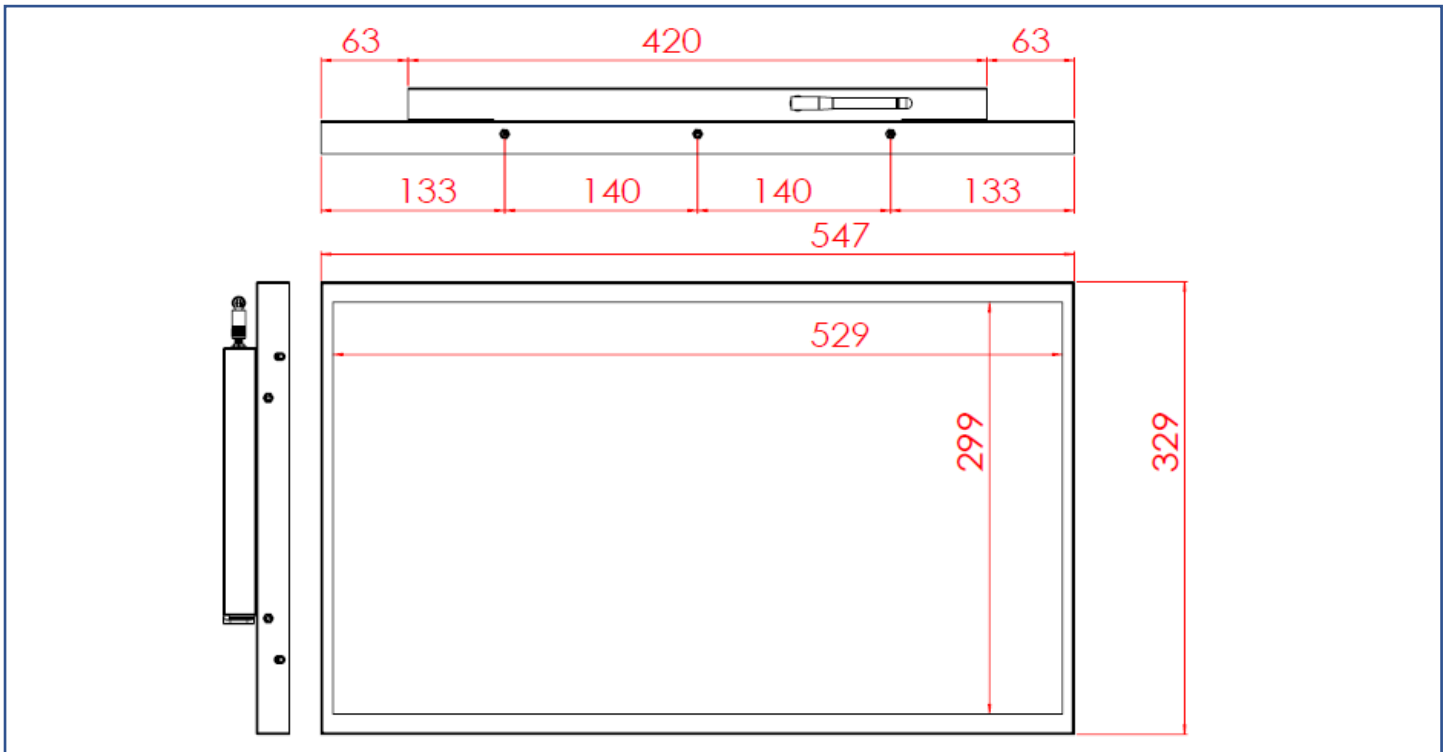

## Cosmetic Inspection Standard

Display Area Allowance			
Defect description	Defective Specifications	Allowance	Remarks
Dot Defect (including dark dot, particles, bubbles, pits, dust, foreign matter)	$D \leq 0.2\text{mm}$	Ignored	D=Diameter
	$0.2 < D \leq 0.7\text{mm}$	$N \leq 5$	N=Quantity
	$0.7 < D \leq 1\text{mm}$	$N \leq 3$	
	$D > 1\text{mm}$	$N \leq 0$	
Linear Defect (including scratches, fluff, particles)	$W \leq 0.15\text{mm}$	Ignored	W=Width
	$0.15 < W \leq 0.5\text{mm}, L \leq 15\text{mm}$	$N \leq 2$	L=Length
	$W > 0.5\text{mm}$ or $L > 15\text{mm}$	NG	

\* Visual inspection distance: 60cm, 90 degree (same for front/side/back)

Front Appearance Allowance (Including Coating)			
Defect description	Defective Specifications	Allowance	Remarks
Dot Defect (including particles, bubbles, pits...etc.)	$D \leq 0.7\text{mm}$	Ignored	D=Diameter
	$0.7 < D \leq 1.5\text{mm}$	$N \leq 3$	N=Quantity
	$D > 1.5\text{mm}$	$N \leq 0$	
Linear Defect (including scratches, fluff, particles)	$W \leq 0.2\text{mm}, L \leq 15\text{mm}$	Ignored	W=Width, L=Length
	$0.2 < W \leq 0.7\text{mm}, L \leq 15\text{mm}$	$N \leq 1$	
	$W > 0.7\text{mm}$ or $L > 15\text{mm}$	NG	

Side / Back Appearance Allowance (Including Coating)			
Defect description	Defective Specifications	Allowance	Remarks
Dot Defect (including particles, bubbles, pits...etc.)	$D \leq 1.5\text{mm}$	Ignored	D=Diameter
	$1.5 < D \leq 3\text{mm}$	$N \leq 8$	N=Quantity
	$D > 3\text{mm}$	$N \leq 2$	
Linear Defect (including scratches, fluff, particles)	$W \leq 0.8\text{mm}, L \leq 15\text{mm}$	Ignored	W=Width, L=Length
	$0.8 < W \leq 1.5\text{mm}, L \leq 15\text{mm}$	$N \leq 5$	
	$W > 1.5\text{mm}$ or $L > 15\text{mm}$	NG	

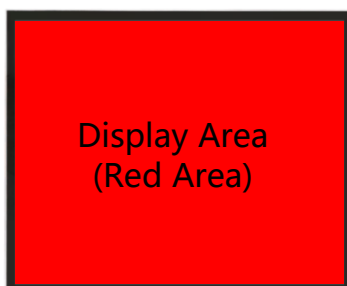

Display Area  
(Red Area)



Front Appearance (Red Area)



Back Appearance