

Product Specifications

Customer	
Model	NTAP238-1-Q2 V500
Model No.	NTAP238<u>XXSXX</u>-Q2A72F8-<u>XXXX</u>-500

* X = A~Z, 0~9 (Depends on Options.)



Records of Revision			
Vision	Modifying	Old Description	New Description
v2112.1	Preliminary Specification		
v2112.2	Add Stylus Pen Option		
v2112.3	Modify the Design of Carton		
v2112.4	New trademark released		

Nextech P Series 23.8" Android All-in-one Touch PC

NTAP238-1-Q2 V500

Features

- ★ 23.8 inch, 1920x1080 (FHD) Resolution
- ★ VA Wide Viewing Angle Technology (178°/178°)
- ★ Rock Chip ARM Cortex A17 RK3288 Quad-Core 1.8GHz CPU
- ★ On Board DDR3 2G Memory
- ★ On Board 8G Flash ROM (Max. upgraded to 32G)
- ★ Micro SD Card Slot x1 (Max. to 64G)
- ★ Android 10.0
- ★ Narrow Bezel, True Flat Projected Capacitive Touch Screen
- ★ 7H Hardness Tempered Cover Glass
- ★ 10 points Multi-touch, Supports NEXTECH Dedicated Stylus
- ★ Metal Cabinet with Diverse Combine Options
- ★ Made in Taiwan, 3 Years Warranty
- ★ Optional High Brightness 1500nits, for Outdoor Environment
- ★ Optional AG Coating/Antibacterial/Privacy Filter Surface Treatment



PSE



BSMI



RoHS



CE



ISO9001



FCC

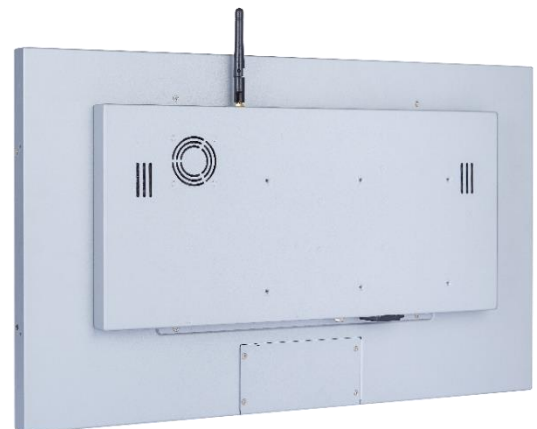

Desktop Stand



Wall Mounting



Open-frame Brackets



Panel Mount

System Specifications

CPU	Rock Chip ARM Cortex A17 RK3288 Quad-Core 1.8GHz
Memory	DDR3 2G
Storage	8G Flash ROM (Max. to 32G)
GPU Chip	Mali T764 GPU
Sound Chip	ES8316 2 Channel HD Audio
Physical Network	1x GbE Lan port (RJ45)
Wireless Network	IEEE 802.11b/g/n 2.4G WIFI and Blue Tooth v2.1+EDR/V3.0/V3.0+HS/V4.0
OS	Android 10.0

Display Specifications

Screen Diagonal	23.8 inch	Display Mode	VA Mode, Normally Black
Display Area	527.04x296.46 mm	Backlight Unit	LED (white LED)
Resolution	1920x1080 (FHD)	Viewing Angle (L/R, U/D)	178°/178° (CR=10)
Contrast Ratio	3000:1	Response Time	16 msec.
Display Ratio	16:9	Backlight Lifetime	>30,000 Hours
Support Colors	16.7M Colors	Operating Temp.	0~50°C
Pixel Pitch	274.5x274.5 um	Storage Temp.	-20~60°C

Display Options

Brightness			
	Brightness	Environment	Model Name
Standard	250nits	General	NTAP238NXSXX-Q2A72F8-XXXX-500
Option 1	1000nits	Outdoor Environment	NTAP238AXSXX-Q2A72F8-XXFX-500
Option 2	1500nits *	Sunlight Readable	NTAP238FX2XX-Q2A72F8-XXFX-500

* Check the data sheets: NTAP238-2-Q2 V500

Nextech P Series 23.8" Android All-in-one Touch PC

NTAP238-1-Q2 V500

Touch Options

Projected Capacitive			
Model Name	NTAP238XPSXX-Q2A72F8-XXXX-500		
Touch Technology	Projected Capacitive	Thickness of Cover Lens	2.9±0.2mm
Allowed Touch Points	10 points	Hardness of Cover Lens	7H
Transparency	≥87%	IK Ratings	IK07
Accuracy	99.00%		

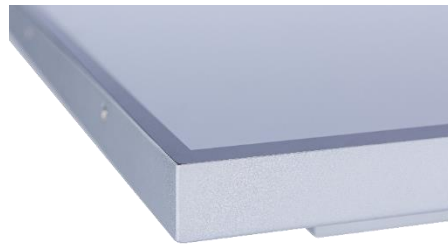

* True Flat, 1mm Bezel

Non-Touch	
Model Name	NTAP238X0SXX-Q2A72F8-XXXX-500

Surface Treatment		
	Description	Model Name
Standard	(none)	NTAP238XXS00-Q2A72F8-XXXX-500
Option 1	Anti-Glare Coating	NTAP238XXSGG-Q2A72F8-XXXX-500
Option 2	Antibacterial (AB Film)	NTAP238XXSAB-Q2A72F8-XXXX-500
Option 3	Anti-Spy (AS Film)	NTAP238XXSSE-Q2A72F8-XXXX-500

Passive Stylus Pen (Option)	
Technology	Passive High Sensitive Knitted Wire Mesh Fiber Tip
Size of tip	6mm
Magnetic Attachment	Yes



Magnetic Attachment

System Options

Material of Cabinet		
	Description	Model Name
Standard	SECC	NTAP238XXSXX-Q2A72F8-SXXX-500
Option 1	Stainless Steel	NTAP238XXSXX-Q2A72F8-LXXX-500
Option 2	Aluminum	NTAP238XXSXX-Q2A72F8-AXXX-500

Color of Cabinet		
	Description	Model Name
Standard	Silver	NTAP238XXSXX-Q2A72F8-XSXX-500
Option 1	White	NTAP238XXSXX-Q2A72F8-XWXX-500
Option 2	Black	NTAP238XXSXX-Q2A72F8-XBXX-500
Options	Other Color	NTAP238XXSXX-Q2A72F8-XXXX-500

* X = A~Z, 0~9 (Depends on Color)

Cooling Fan		
	Description	Model Name
Standard	7 Blades/4000r.p.m/28.3dB	NTAP238XXSXX-Q2A72F8-XXFX-500
Option	Fanless	NTAP238XXSXX-Q2A72F8-XX0X-500

Power Input		
	Description	Model Name
Standard	12VDC-in, with AC/DC Adapter	NTAP238XXSXX-Q2A72F8-XXX2-500
Option	100~240V AC, C14 AC Power Socket	NTAP238XXSXX-Q2A72F8-XXXA-500



DC-in



AC-in

Input /Output System

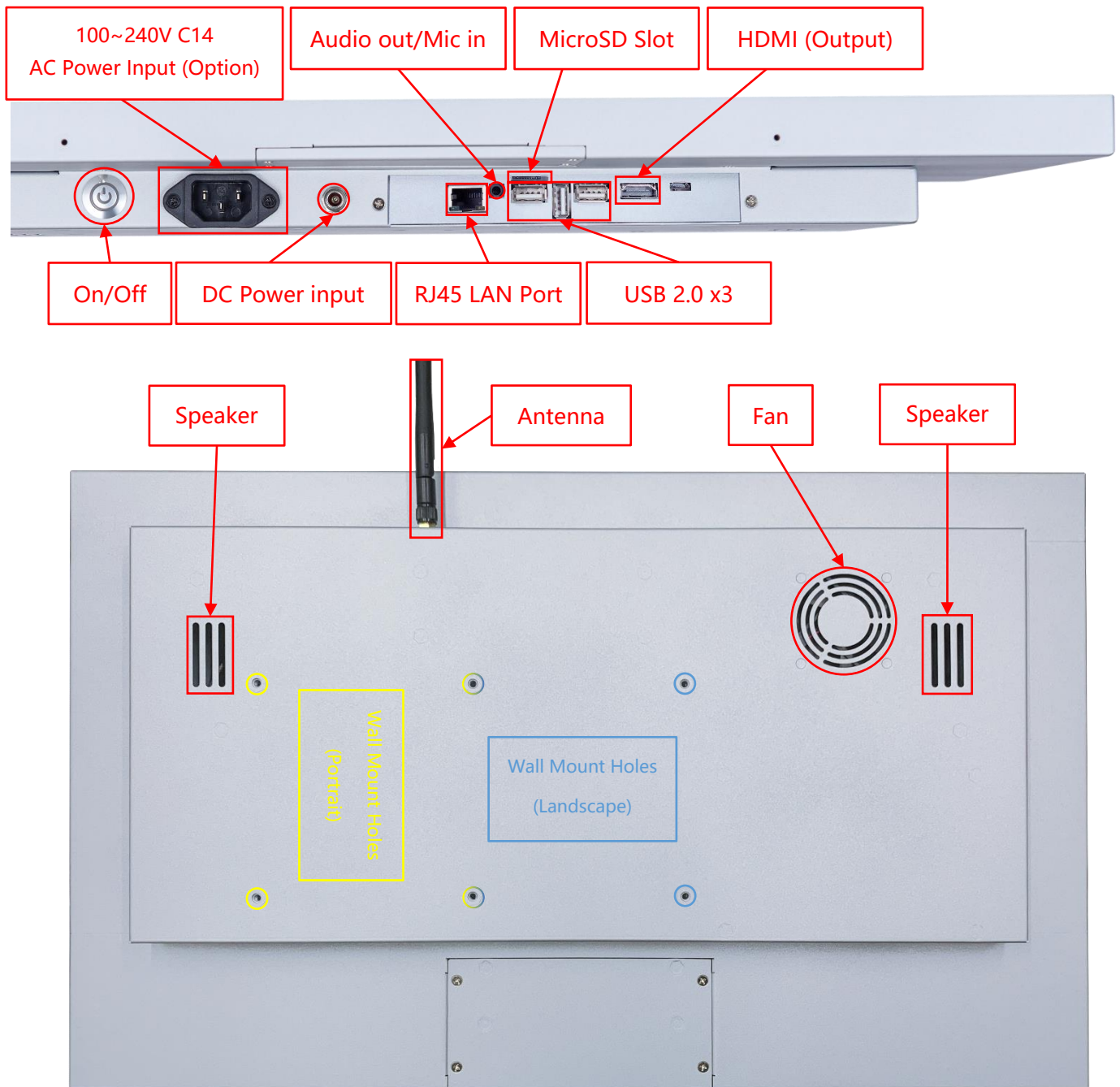

Input / Output	Connectors	Input / Output	Connectors
HDMI (Output)	1	USB 2.0	3
Audio Output /Mic Input (3.5mm)	1	MicroSD Card Slot	1
DC Power Input	1	LAN (RJ45)	1
AC Power Input	Option	Wi-Fi/Bluetooth & Antenna	1
Speakers	2W x2		

Front Cover (Option)

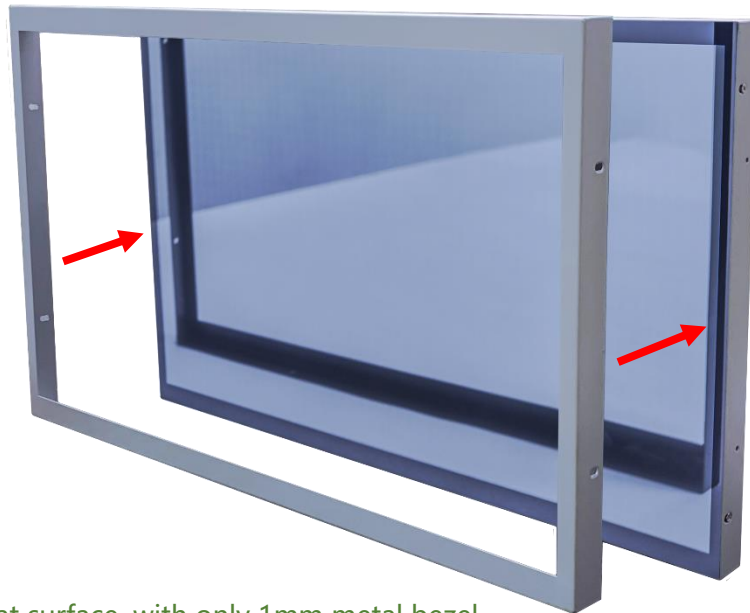

The standard **NTAP238** is true flat surface, with only 1mm metal bezel.
To protect the corners of the touch screen, the **Front Cover** can be added.



The watertight gasket can be added between the **Front Cover** and **NTAP238**.
It complies **IP65** on front.

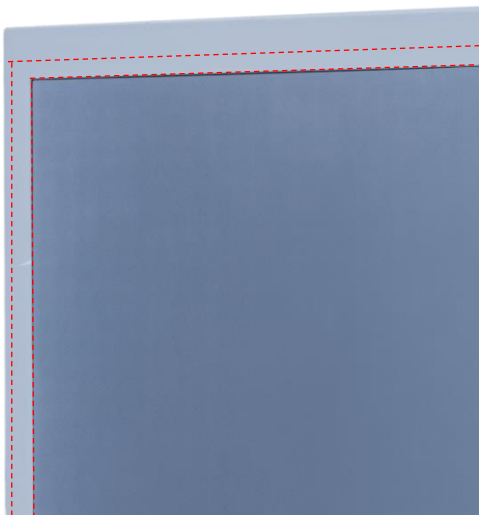

Open-frame Brackets (Option)

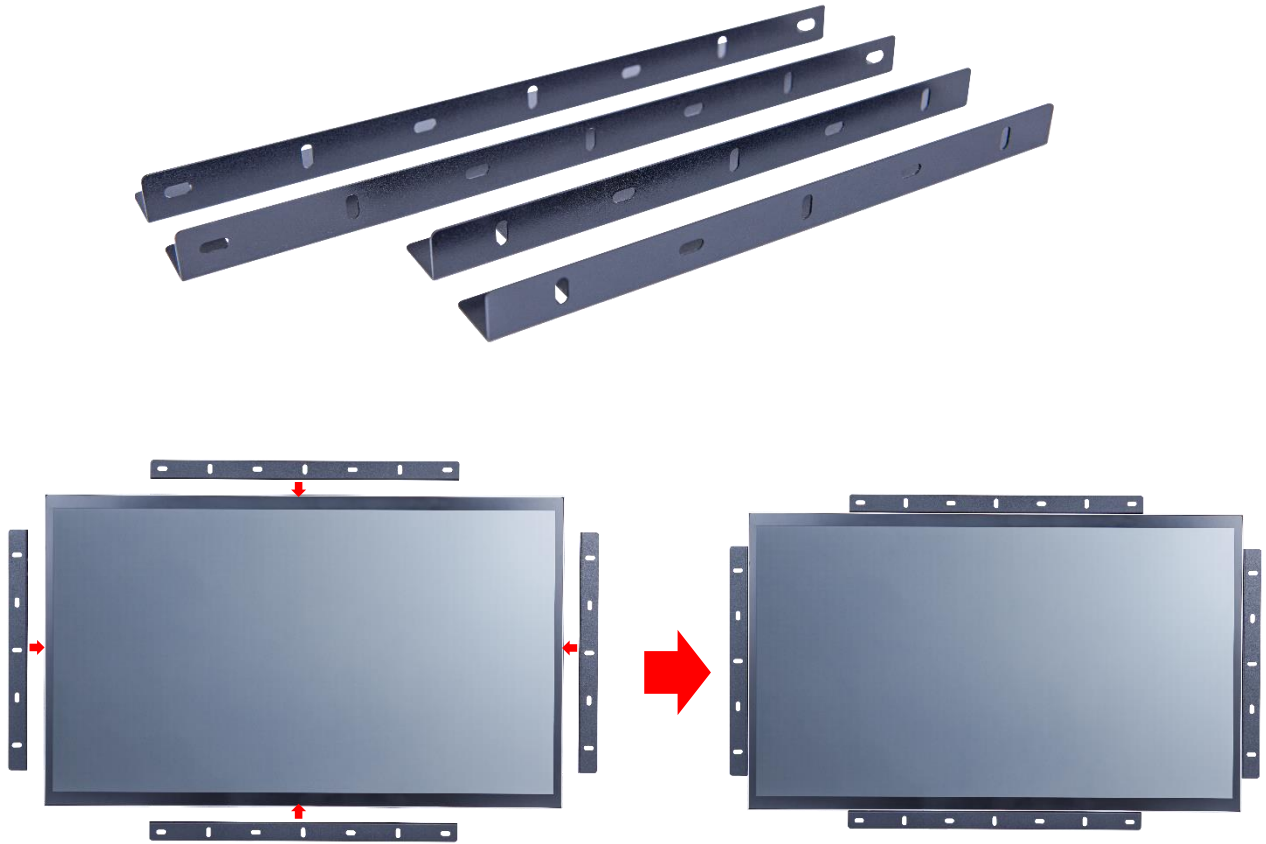

Dimension for Installing with Open-frame Brackets

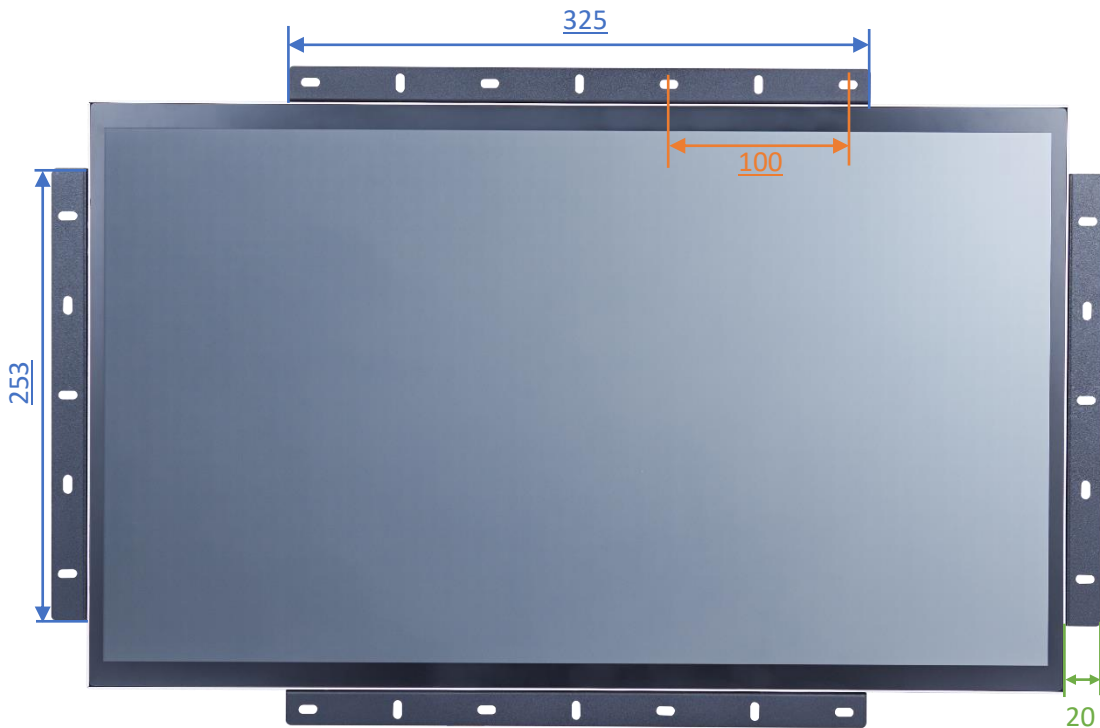

Panel Mount Kits (Option)



Dimension for Installing with Panel Mount Kits

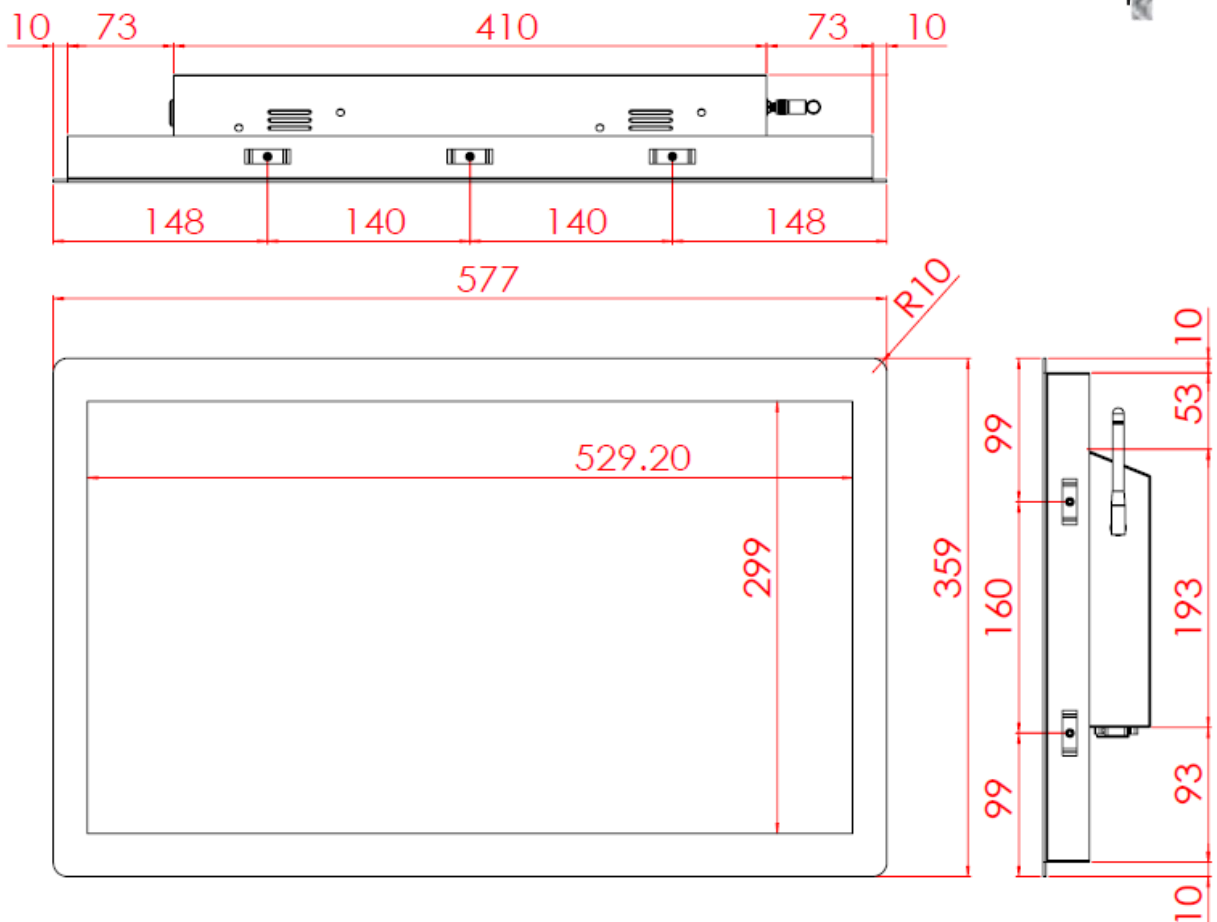

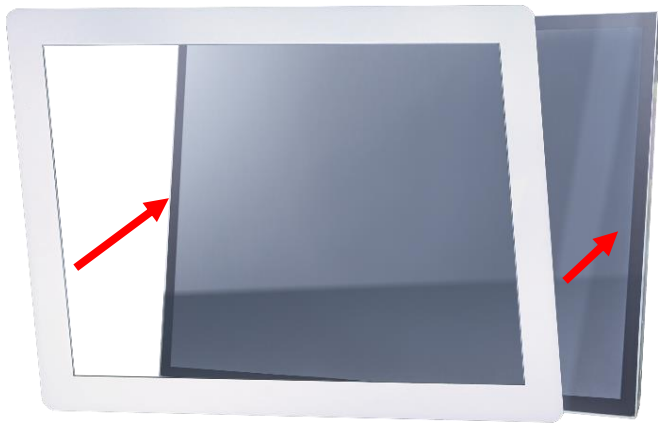

Step 1: Assemble the front module with the screen body. (This step is pre-assembled at the factory.)

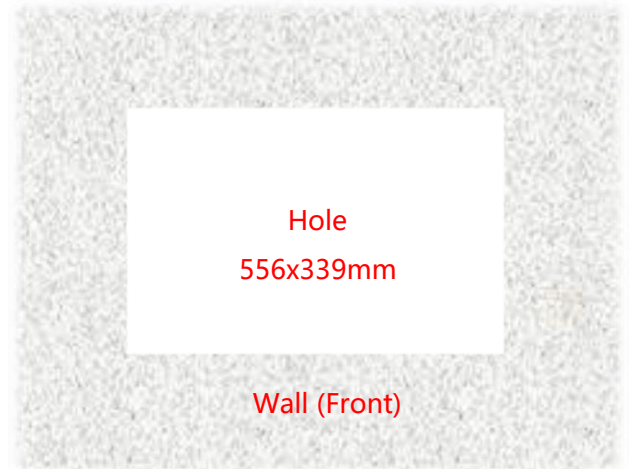

Step 2: Insert the screen from the front into the pre-cut opening.

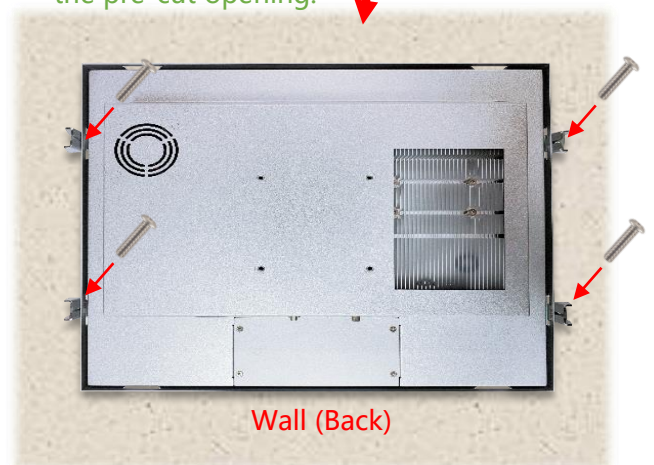

Step 3: Attach the clips from the back and secure with screws. (Up to 9 clips can be installed as needed or per positional limitations.)

Nextech P Series 23.8" Android All-in-one Touch PC

NTAP238-1-Q2 V500

Desktop Stand (Option)

Item	B Stand	Part No.	DST-0B002/DST-1B002
Mounting Pattern	100x100 / 75x75 mm	Dimension (WxHxD)	203x275x227 mm
Material	Steel/Plastic/Aluminum	Net Weight	1.8 KG
Tilt (Hinge)	-2° ~ +180°	Support Max. Weight	15 KG



Item	Z Stand	Part No.	DST-0BZ01/DST-1BZ01
Mounting Pattern	100x100 / 75x75 mm	Dimension (WxHxD)	190x240x41.6
Material	SECC	Net Weight	2.6 KG
Tilt (Hinge)	±360°	Support Max. Weight	15 KG

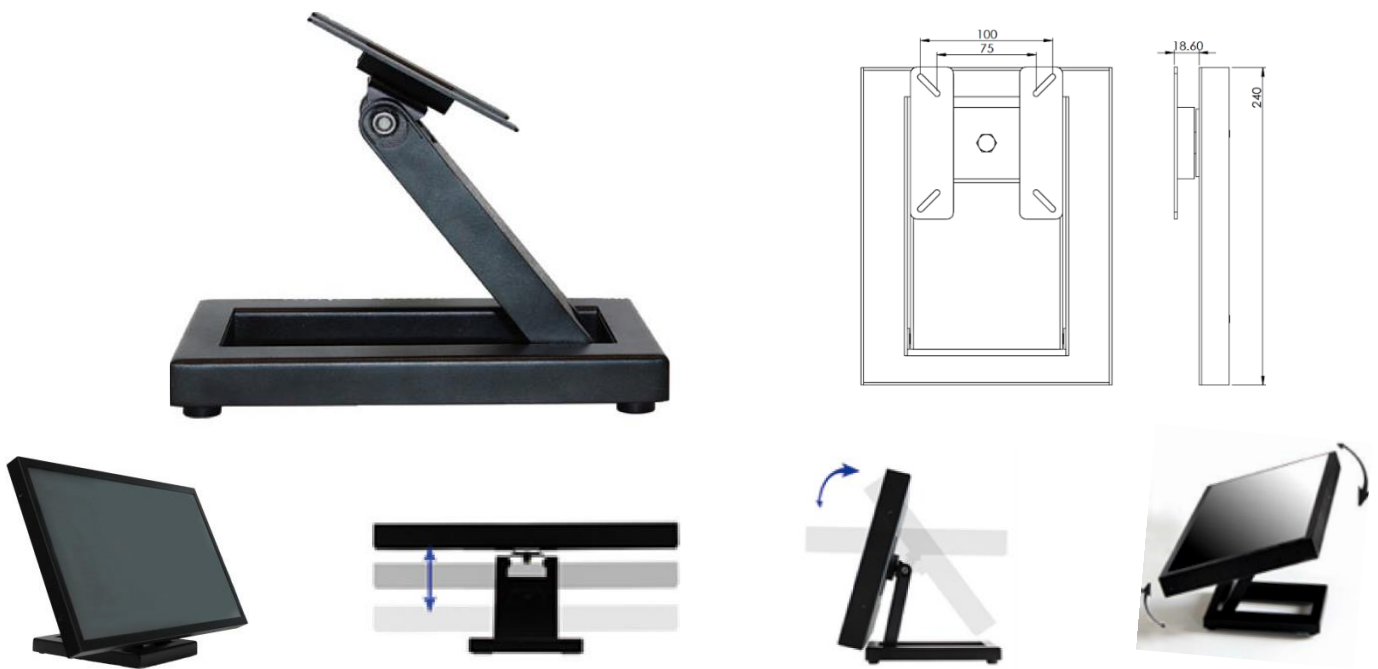

Wall Mount Bracket (Option)

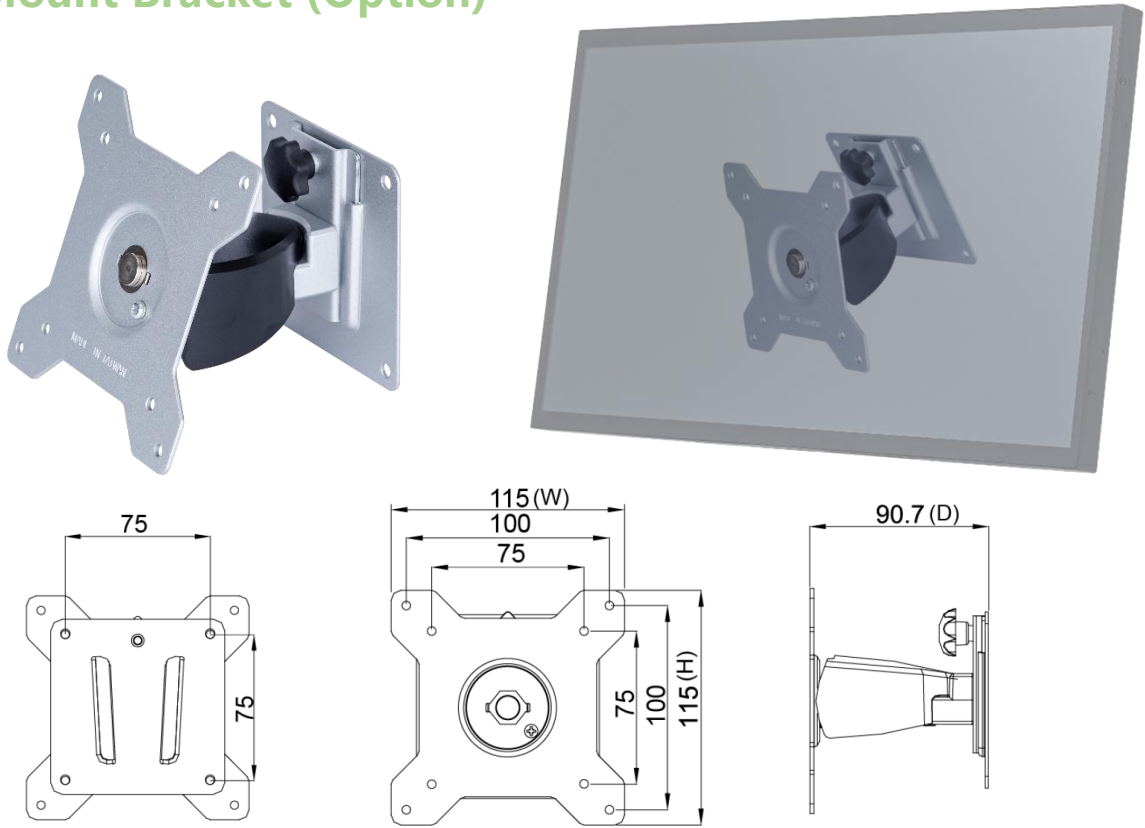

Packing Information



Unit Carton Size	665x160x510 mm
Unit N. Weight	≤5.9 KG
Unit G. Weight	≤7.9 KG
Units per Pallet	30 units
Pallet Size	120x100x171 CM

Physical Specifications

Dimension	547x329x48(±2)mm (W/O Antenna)	Net Weight	≤5.9 KG
VESA Mounting	100x100 mm	Gross Weight	≤7.9 KG

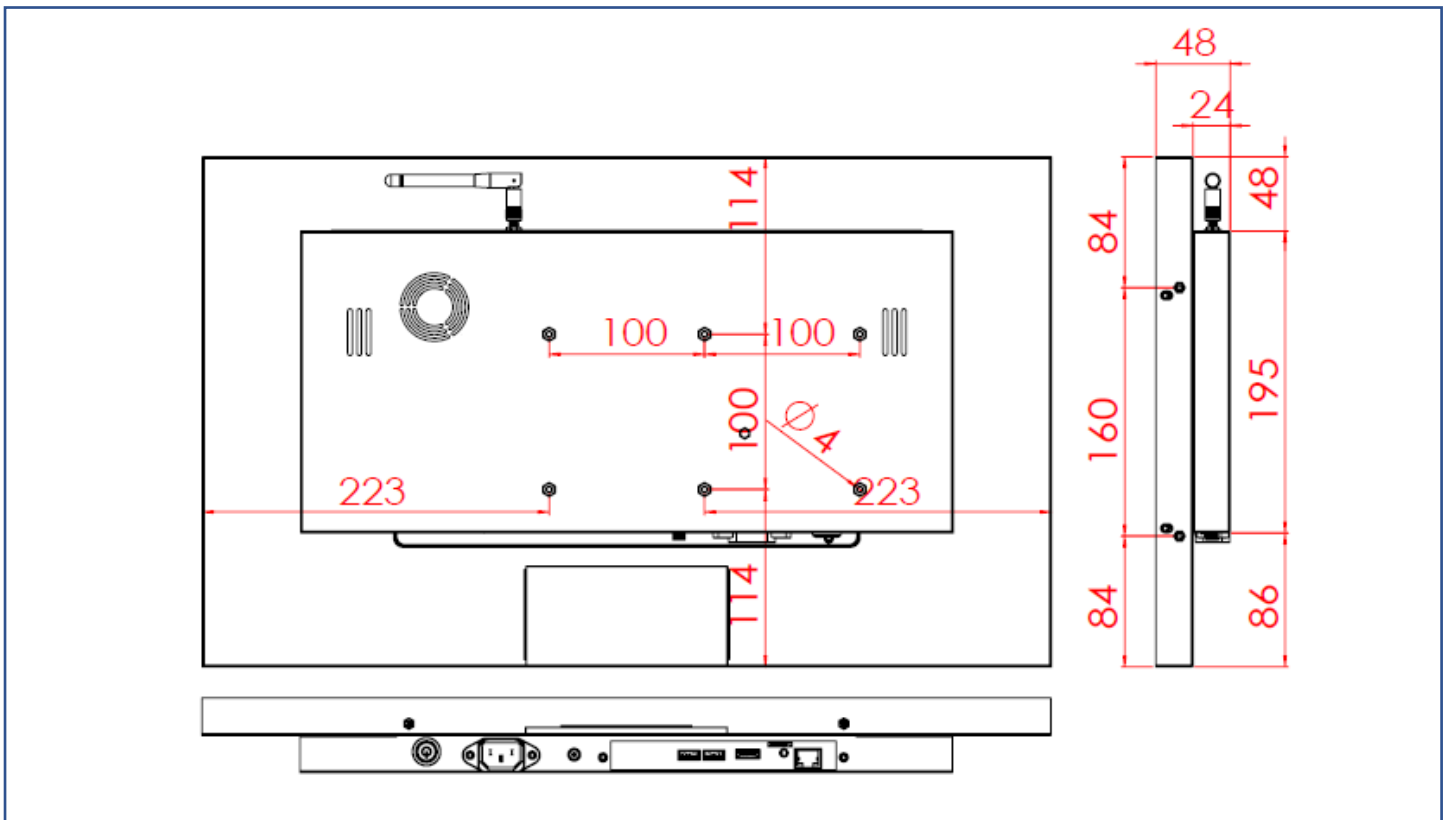
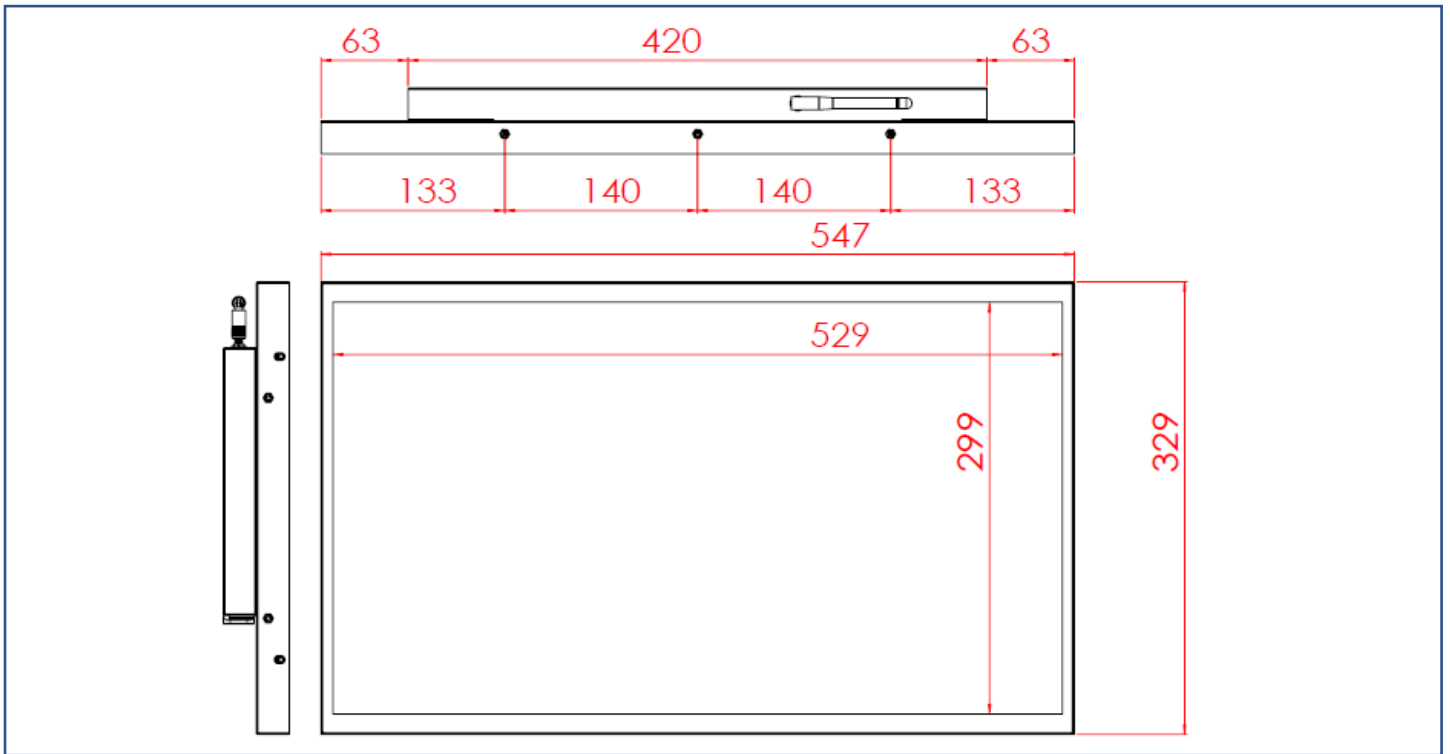

Cosmetic Inspection Standard

Display Area Allowance			
Defect description	Defective Specifications	Allowance	Remarks
Dot Defect (including dark dot, particles, bubbles, pits, dust, foreign matter)	$D \leq 0.2\text{mm}$	Ignored	D=Diameter
	$0.2 < D \leq 0.7\text{mm}$	$N \leq 5$	N=Quantity
	$0.7 < D \leq 1\text{mm}$	$N \leq 3$	
	$D > 1\text{mm}$	$N \leq 0$	
Linear Defect (including scratches, fluff, particles)	$W \leq 0.15\text{mm}$	Ignored	W=Width
	$0.15 < W \leq 0.5\text{mm}, L \leq 15\text{mm}$	$N \leq 2$	L=Length
	$W > 0.5\text{mm}$ or $L > 15\text{mm}$	NG	

* Visual inspection distance: 60cm, 90 degree (same for front/side/back)

Front Appearance Allowance (Including Coating)			
Defect description	Defective Specifications	Allowance	Remarks
Dot Defect (including particles, bubbles, pits...etc.)	$D \leq 0.7\text{mm}$	Ignored	D=Diameter
	$0.7 < D \leq 1.5\text{mm}$	$N \leq 3$	N=Quantity
	$D > 1.5\text{mm}$	$N \leq 0$	
Linear Defect (including scratches, fluff, particles)	$W \leq 0.2\text{mm}, L \leq 15\text{mm}$	Ignored	W=Width, L=Length
	$0.2 < W \leq 0.7\text{mm}, L \leq 15\text{mm}$	$N \leq 1$	
	$W > 0.7\text{mm}$ or $L > 15\text{mm}$	NG	

Side / Back Appearance Allowance (Including Coating)			
Defect description	Defective Specifications	Allowance	Remarks
Dot Defect (including particles, bubbles, pits...etc.)	$D \leq 1.5\text{mm}$	Ignored	D=Diameter
	$1.5 < D \leq 3\text{mm}$	$N \leq 8$	N=Quantity
	$D > 3\text{mm}$	$N \leq 2$	
Linear Defect (including scratches, fluff, particles)	$W \leq 0.8\text{mm}, L \leq 15\text{mm}$	Ignored	W=Width, L=Length
	$0.8 < W \leq 1.5\text{mm}, L \leq 15\text{mm}$	$N \leq 5$	
	$W > 1.5\text{mm}$ or $L > 15\text{mm}$	NG	

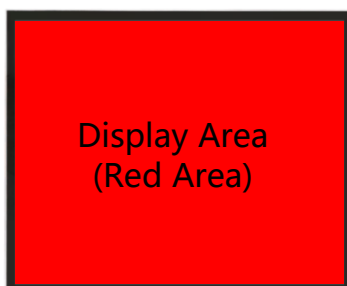

Display Area
(Red Area)



Front Appearance (Red Area)



Back Appearance